

# MÉTIS CONNECTIONS PUZZLE LEGEND

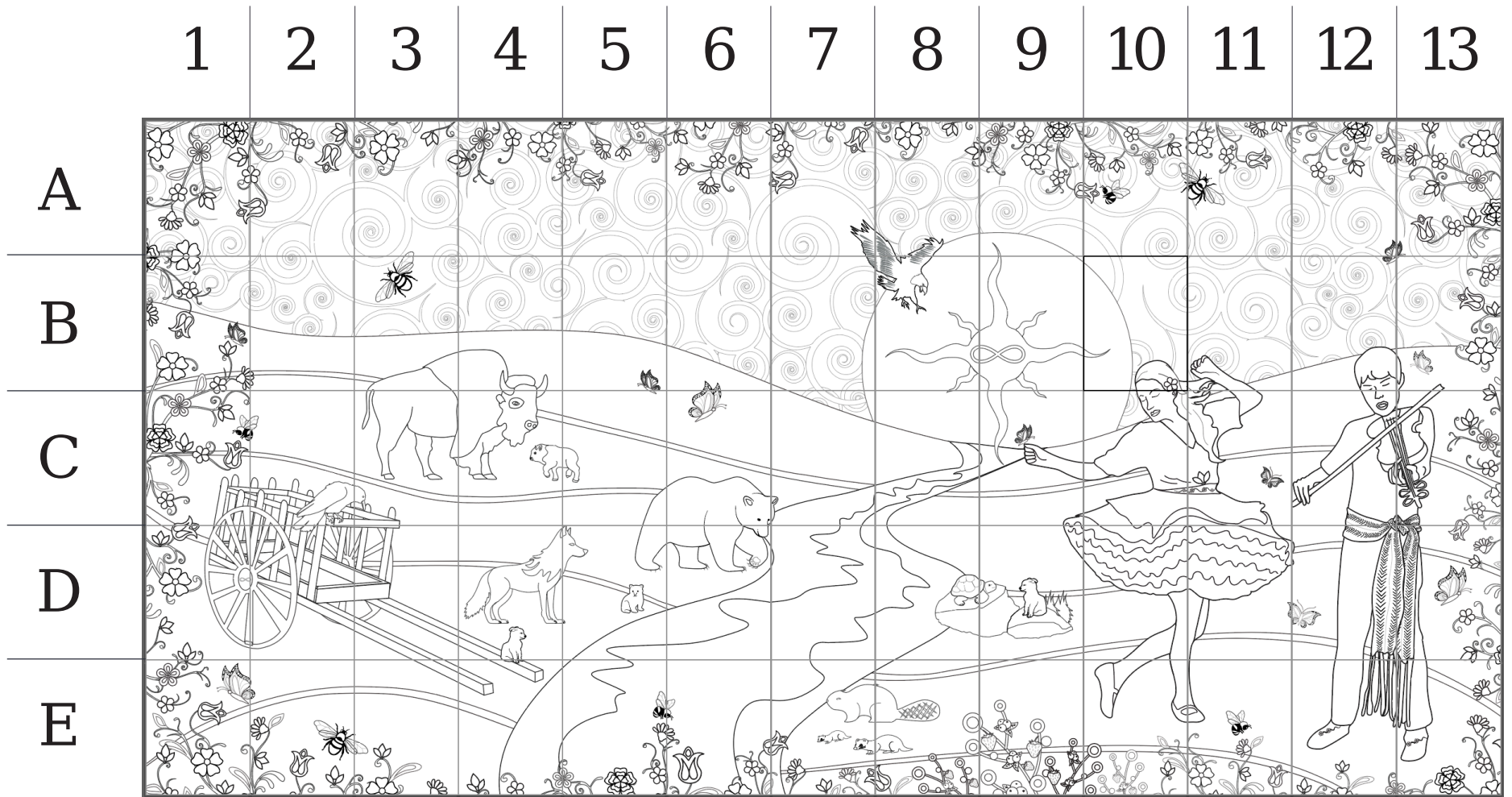

























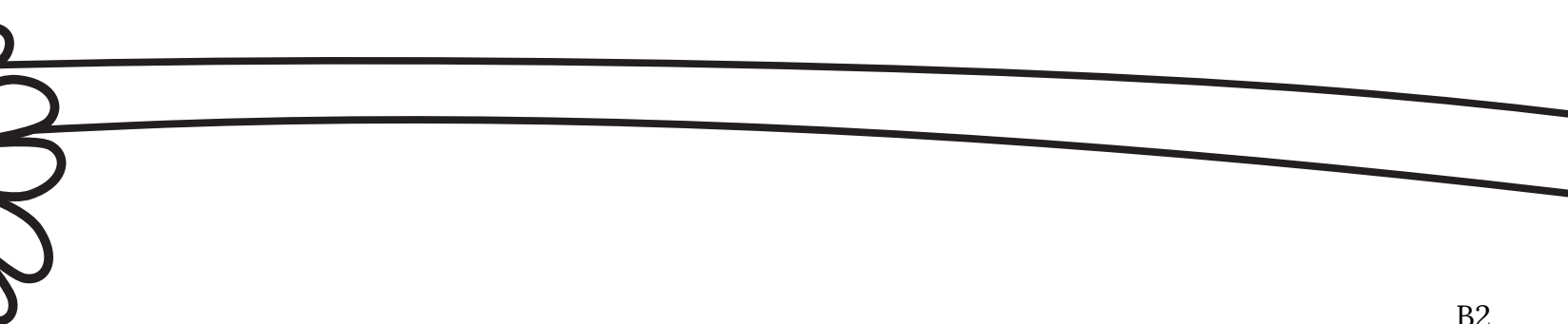
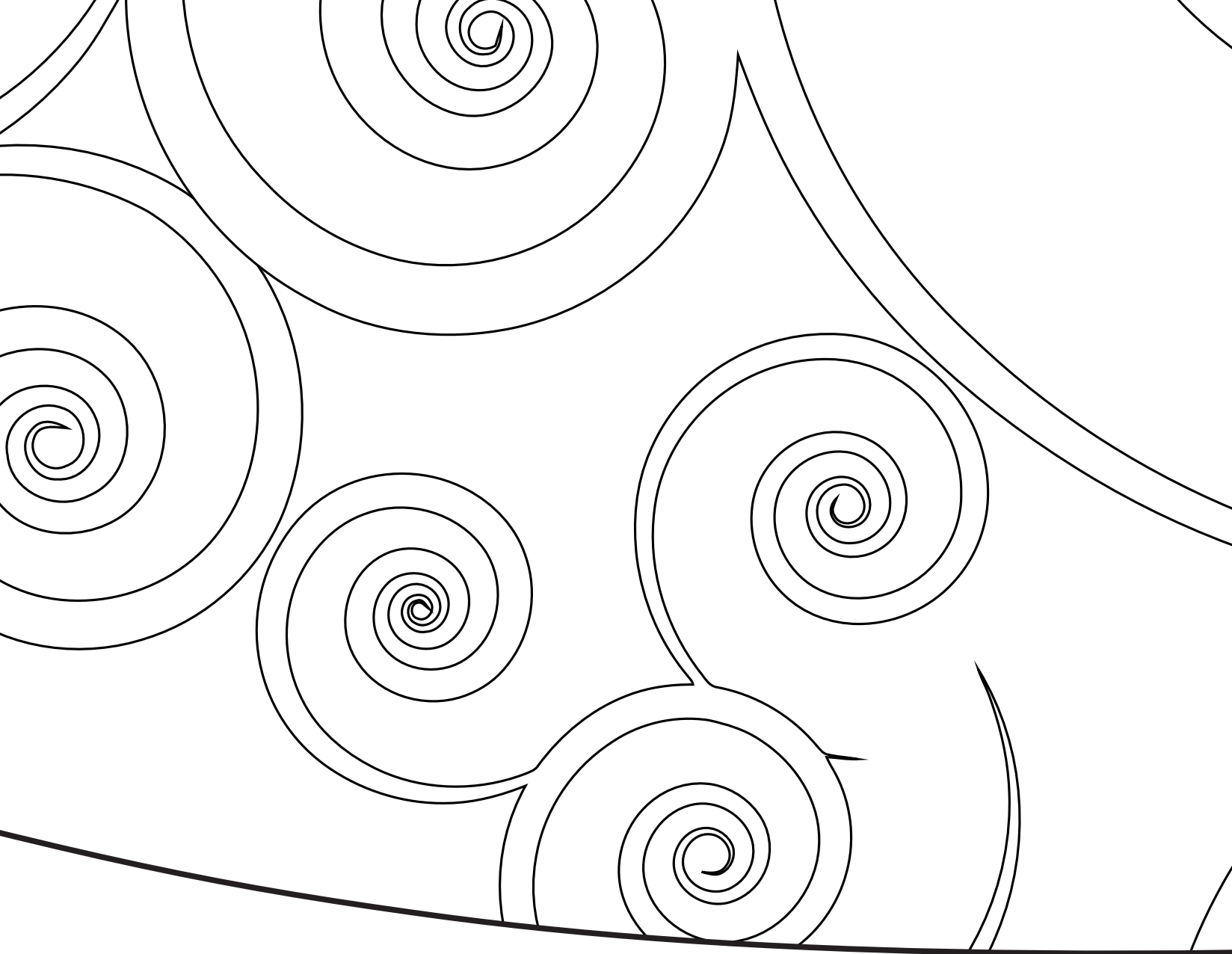



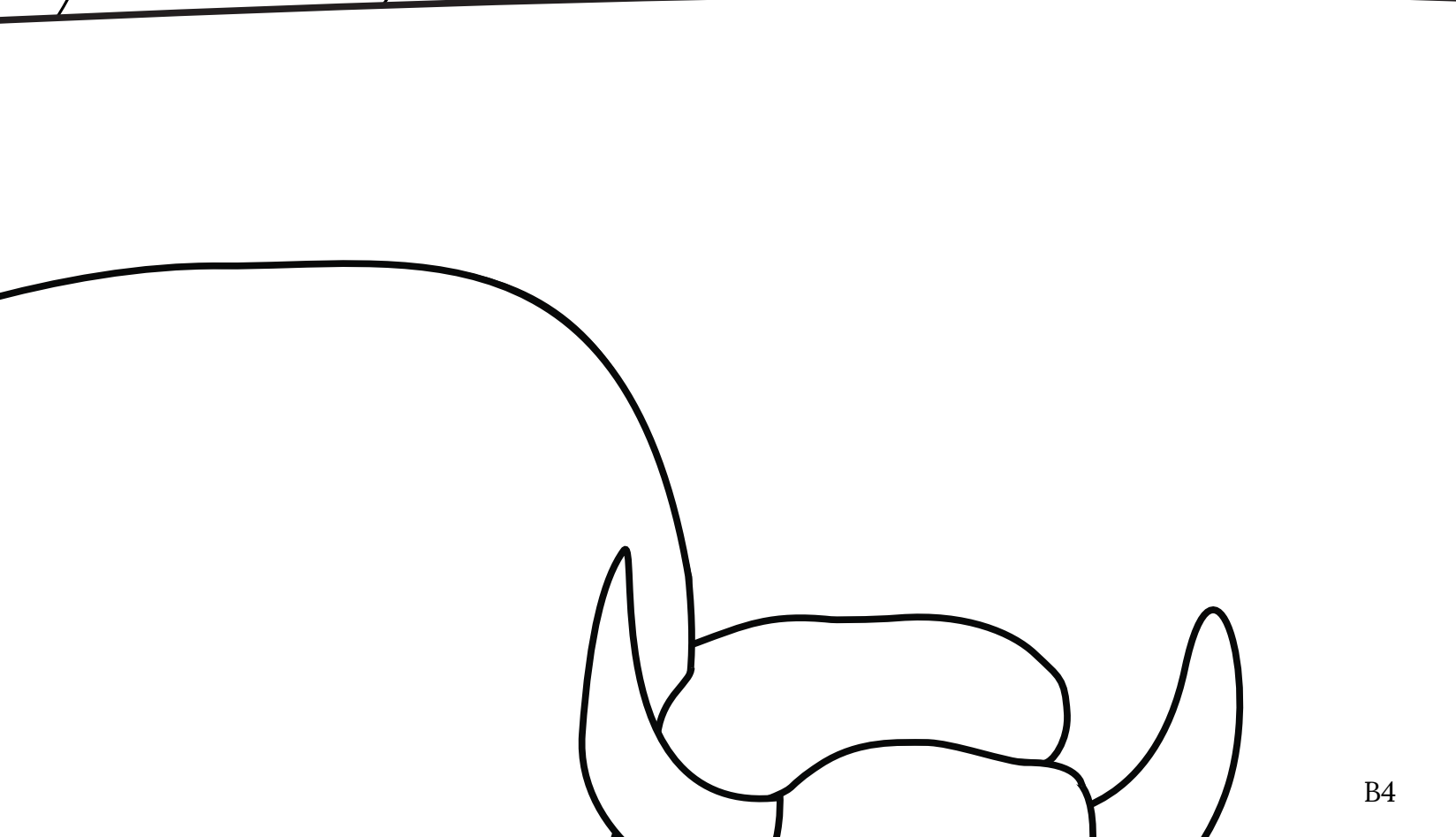
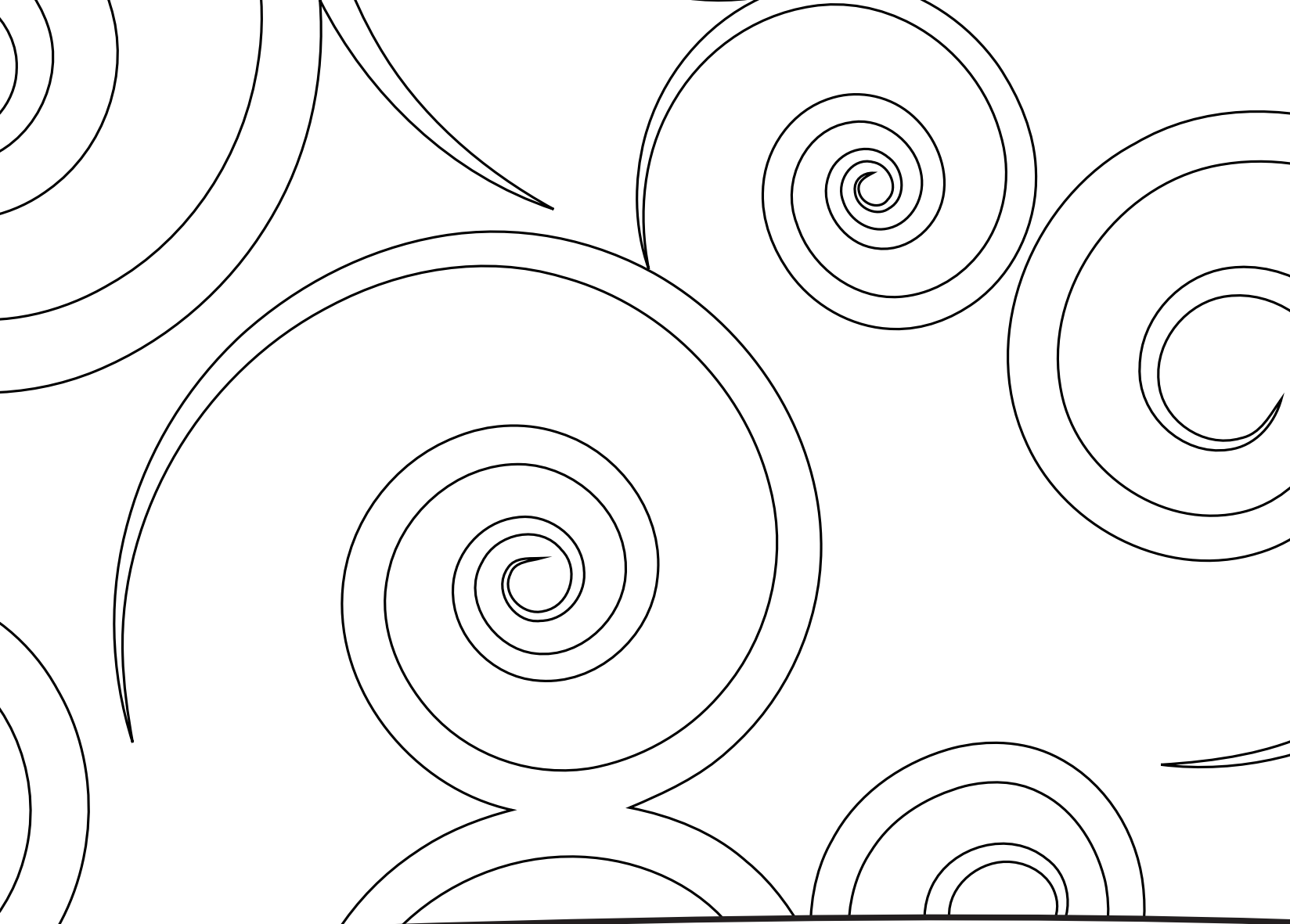

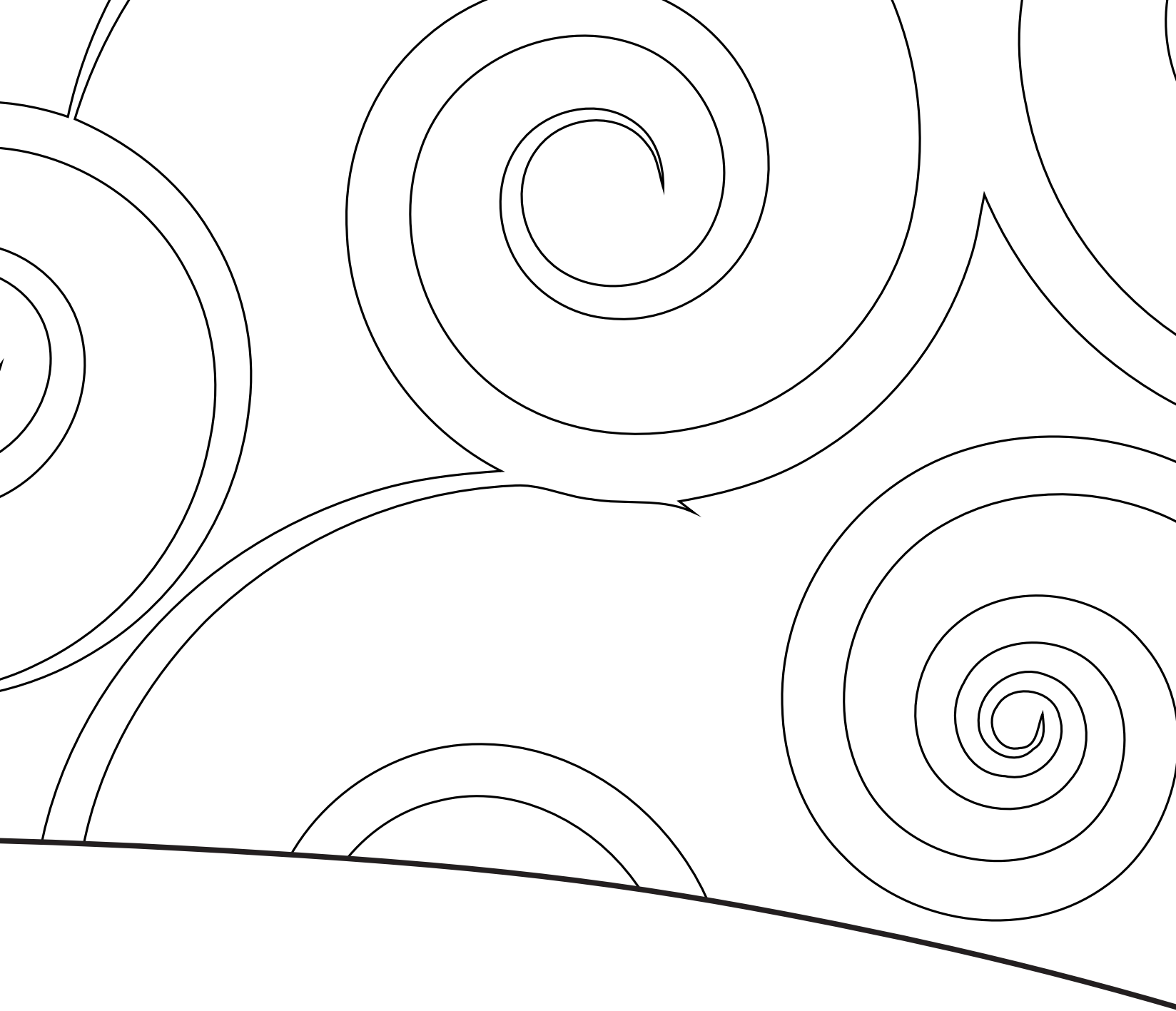

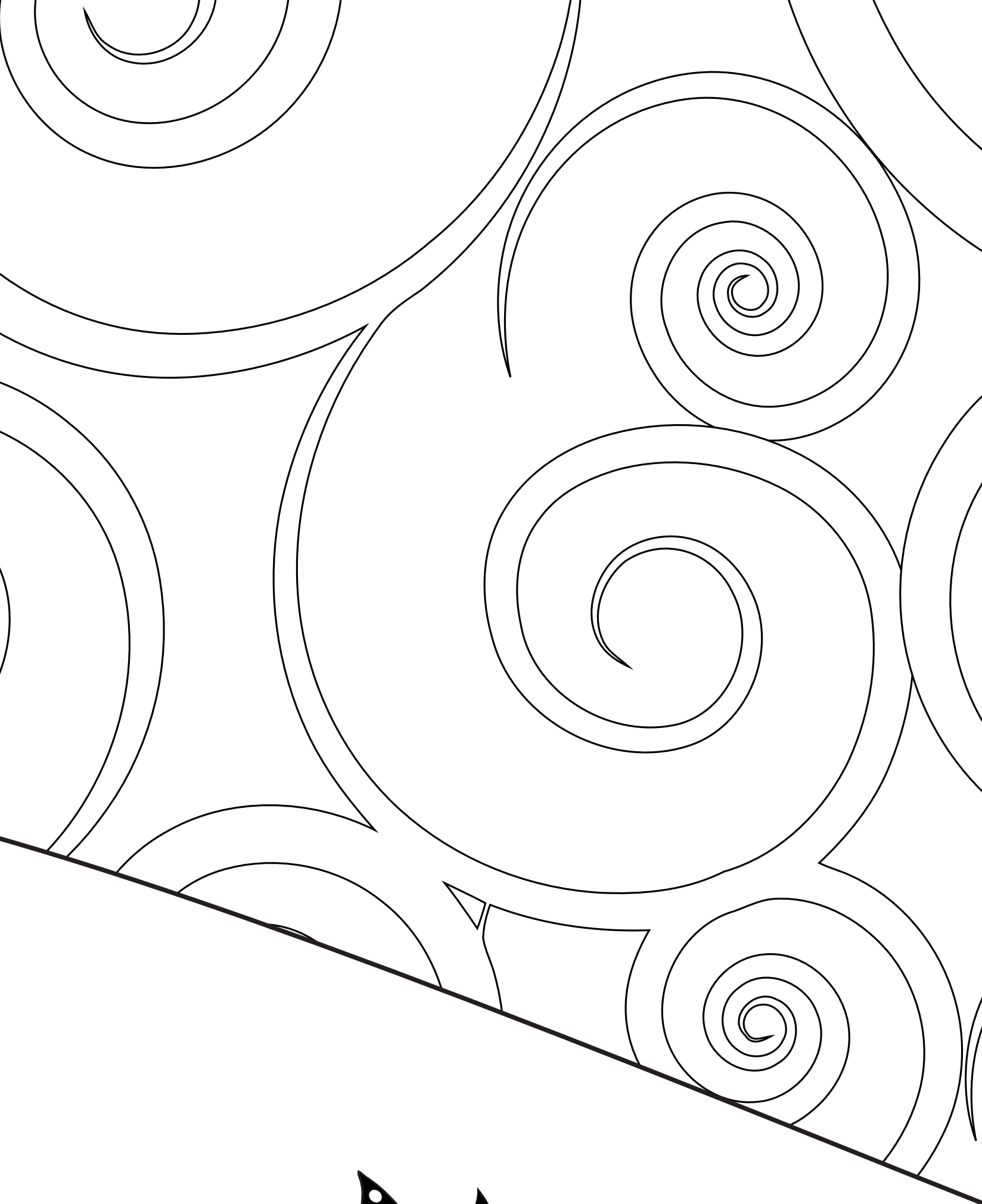



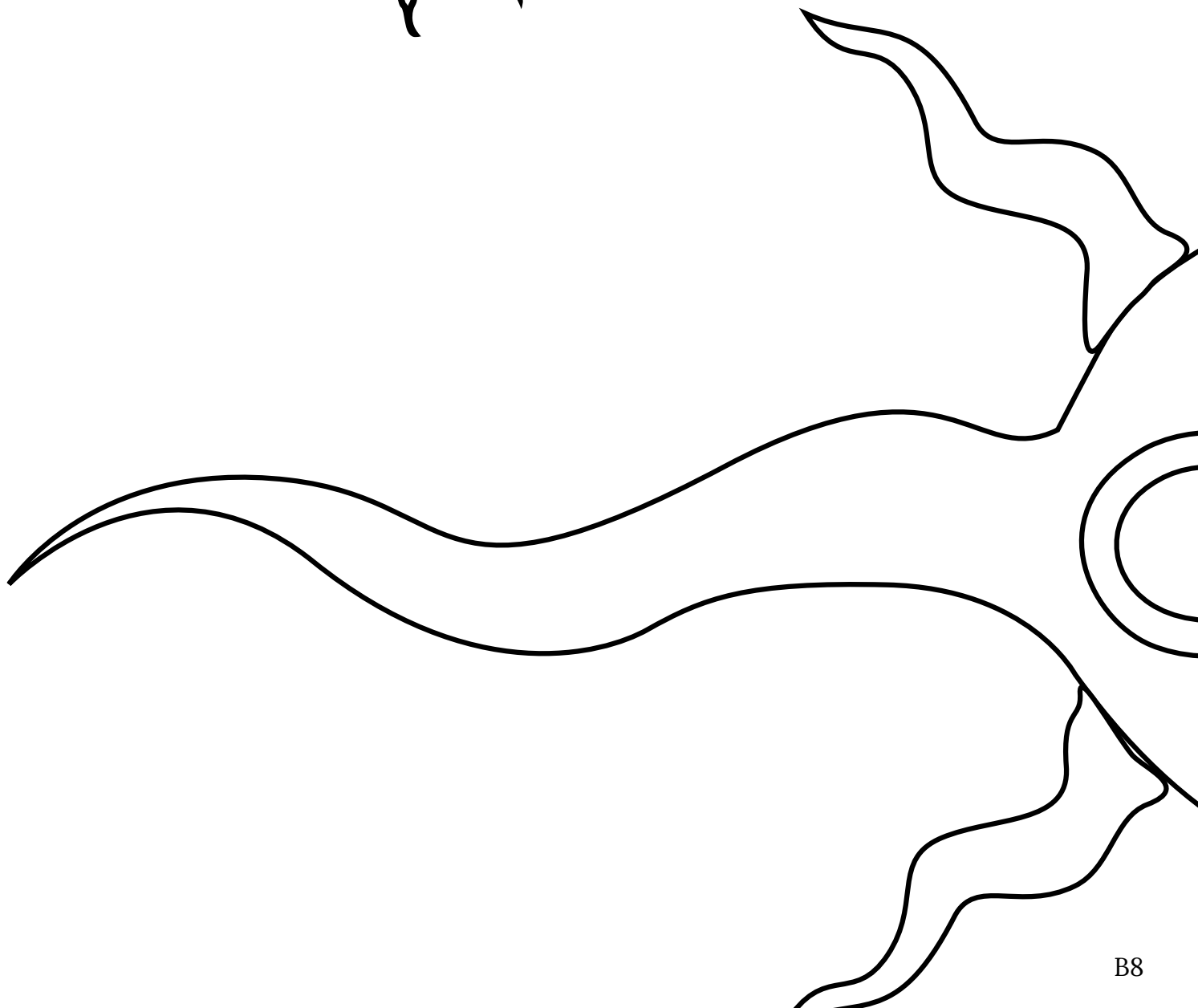

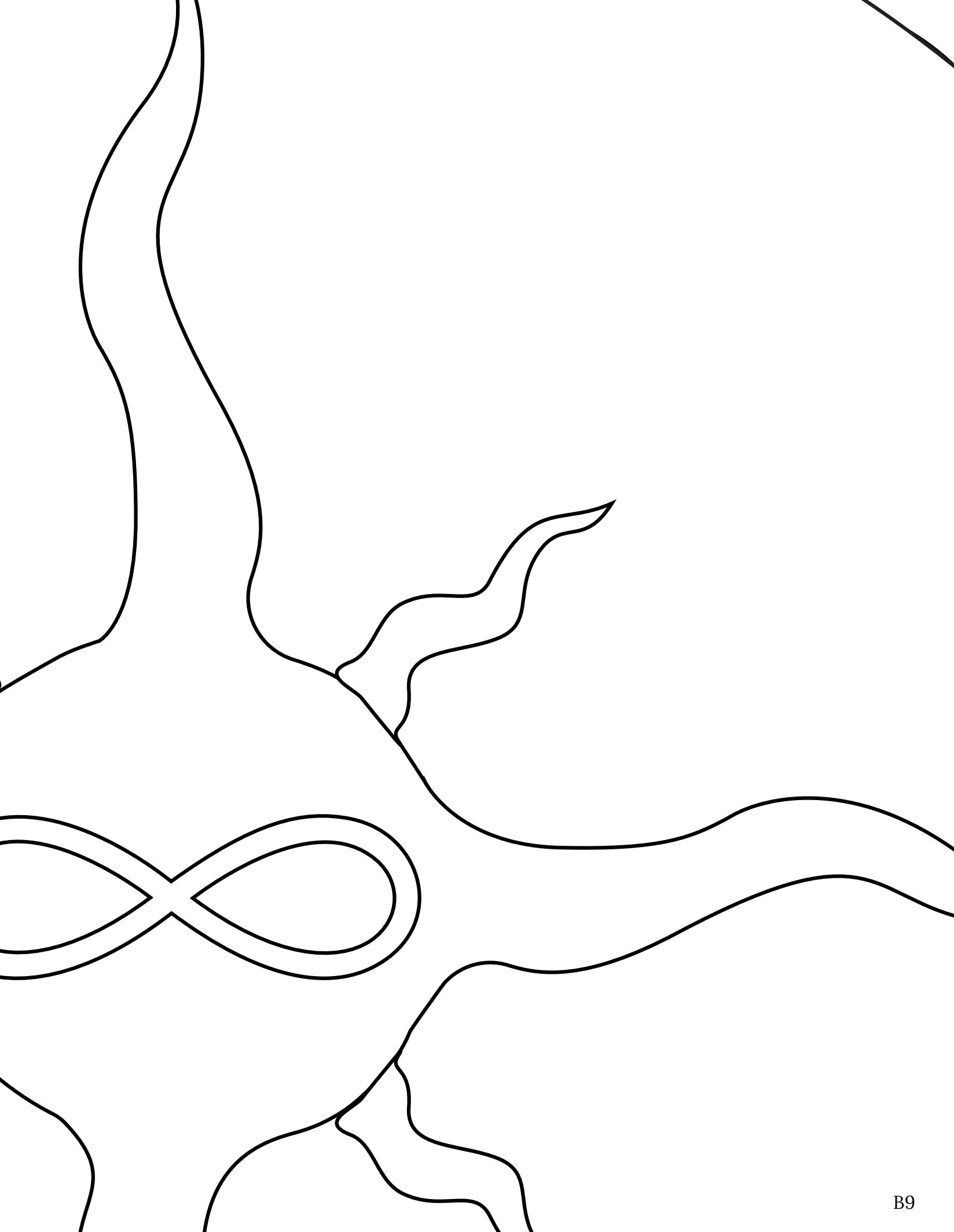







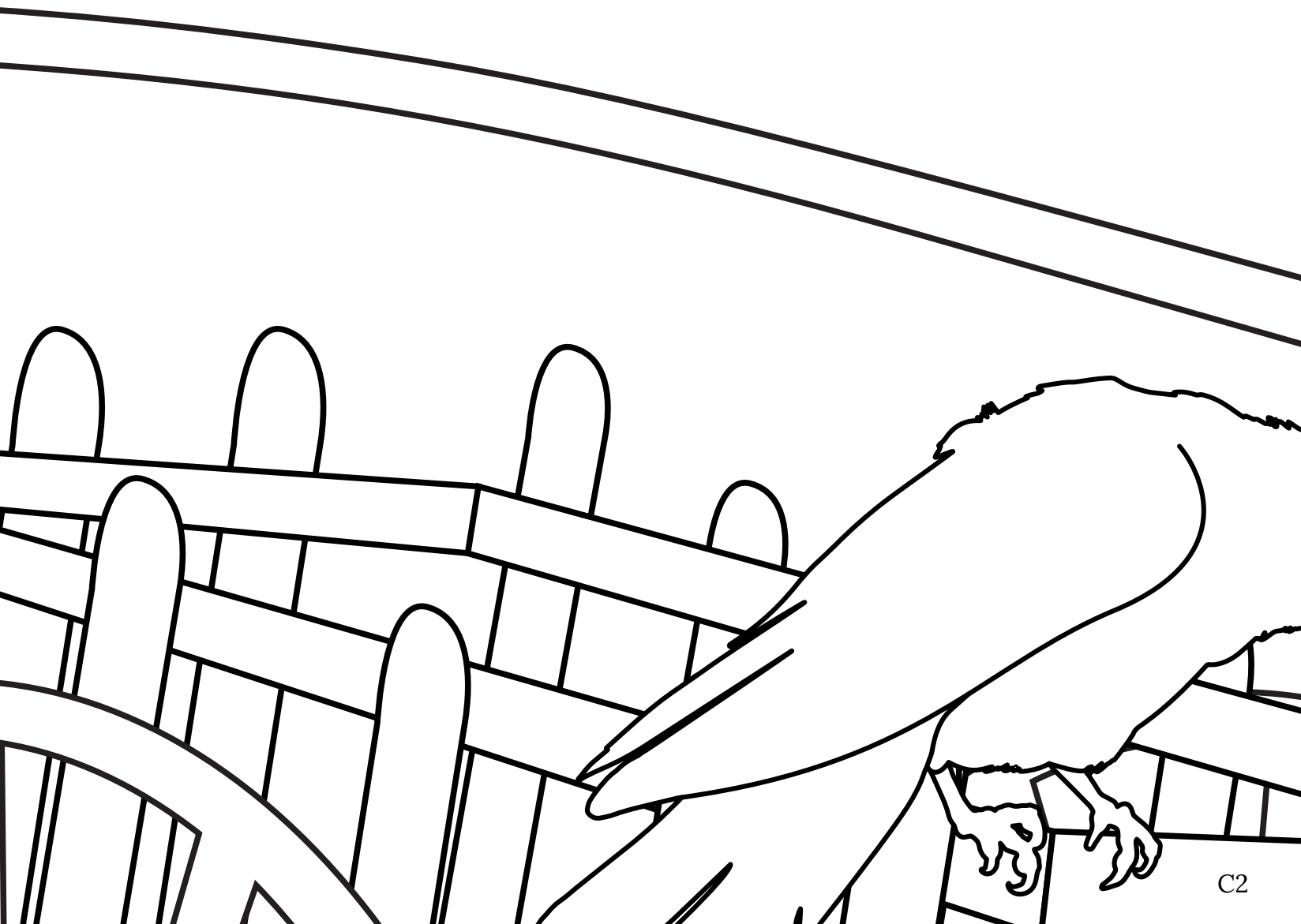

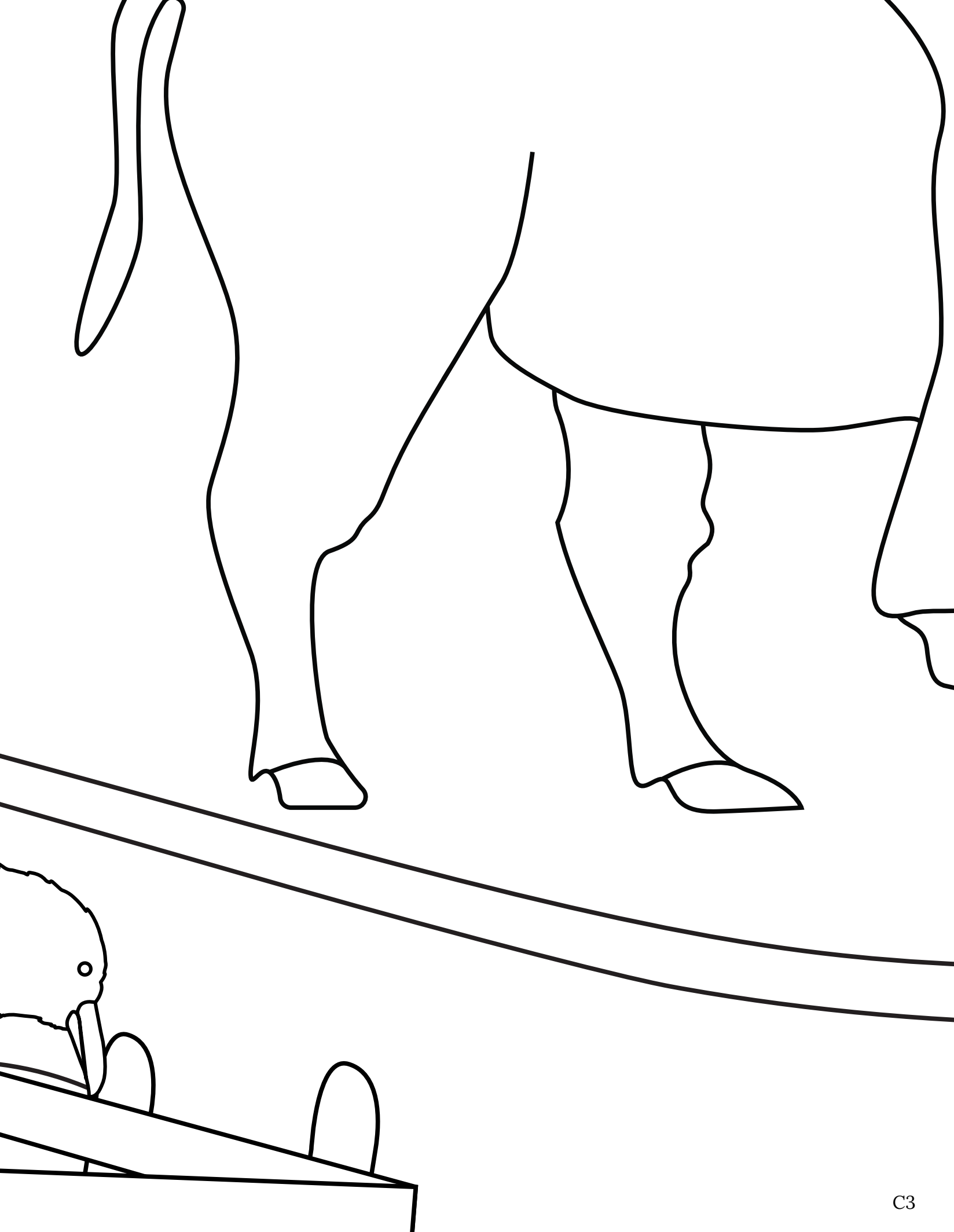

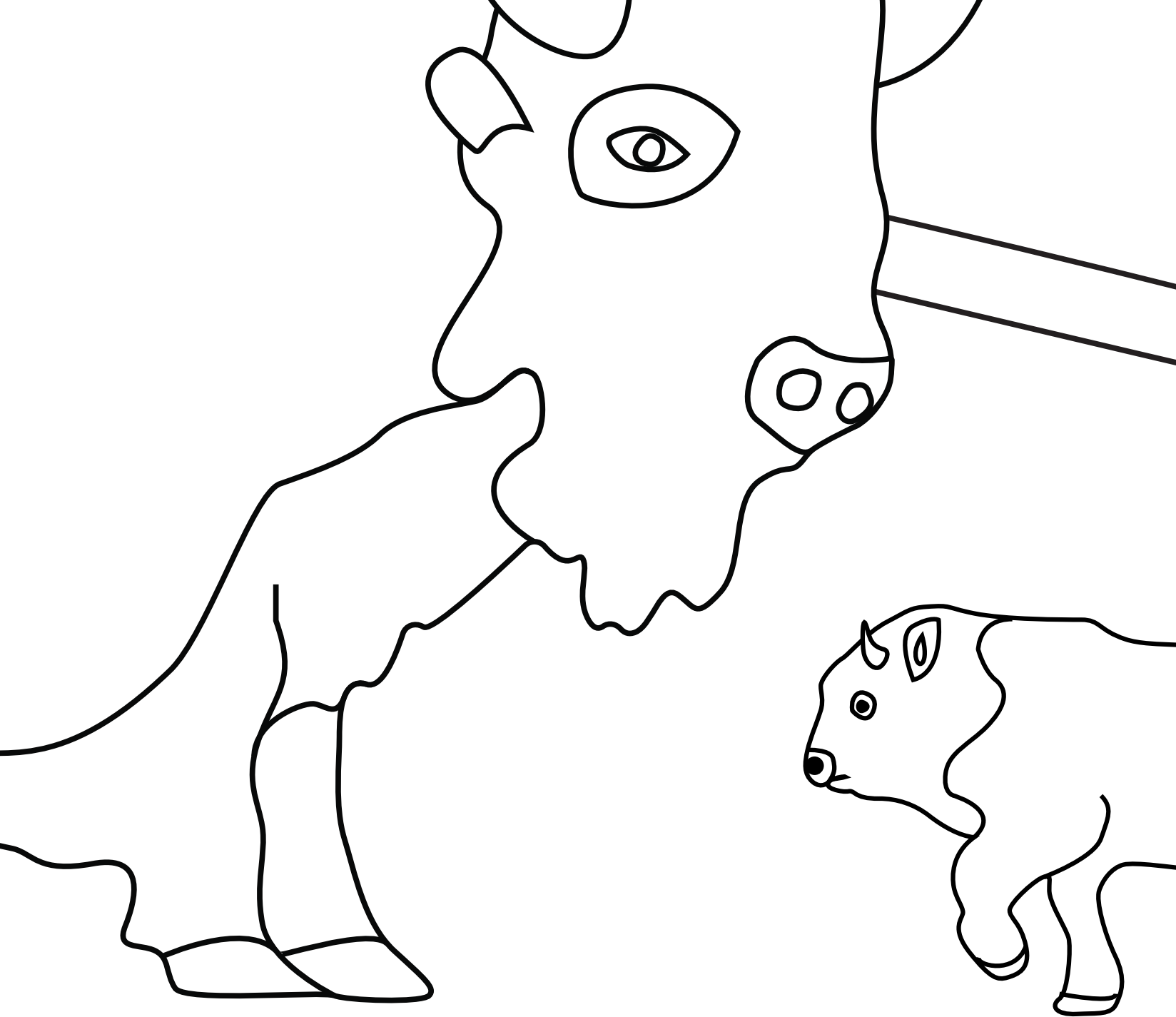

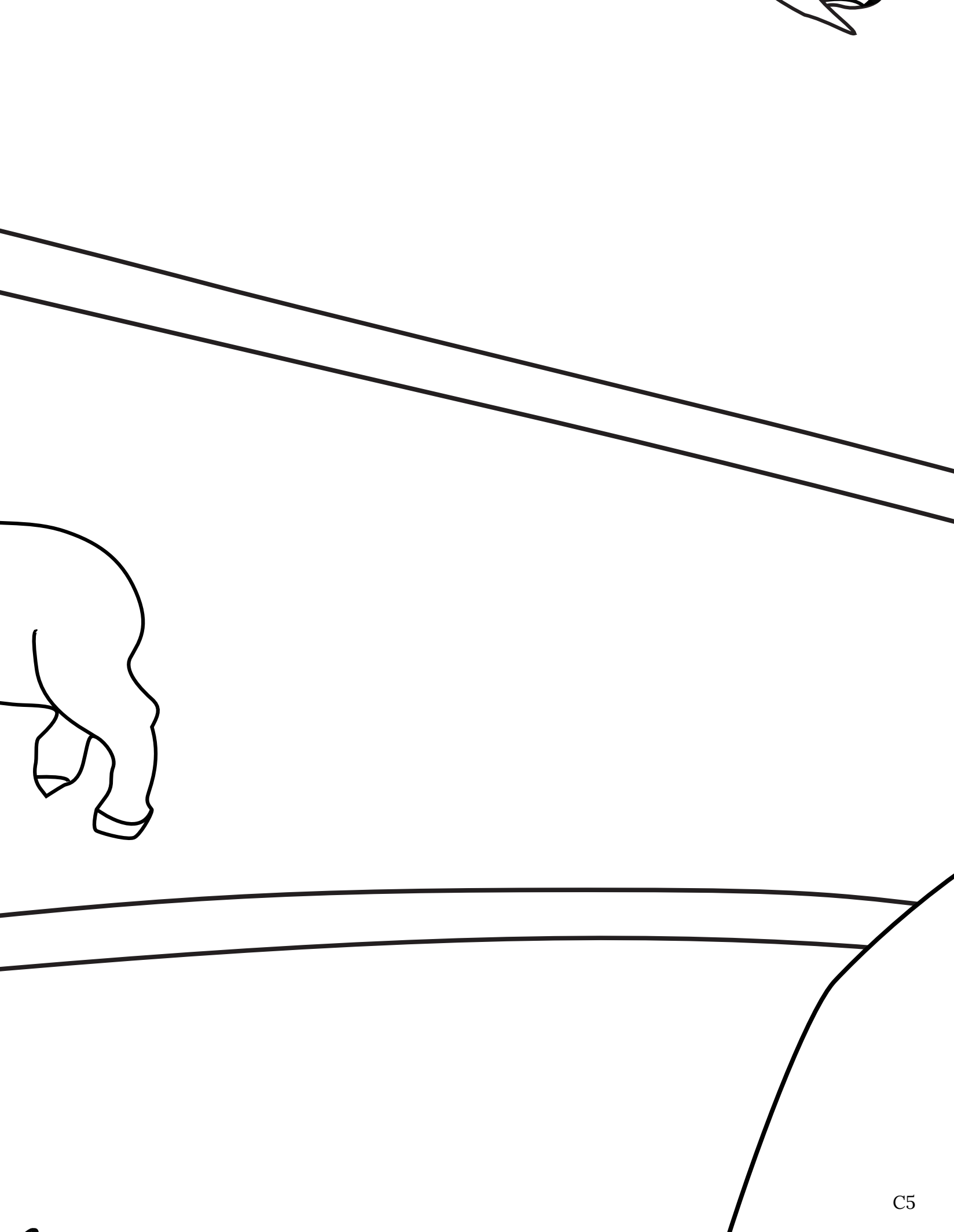

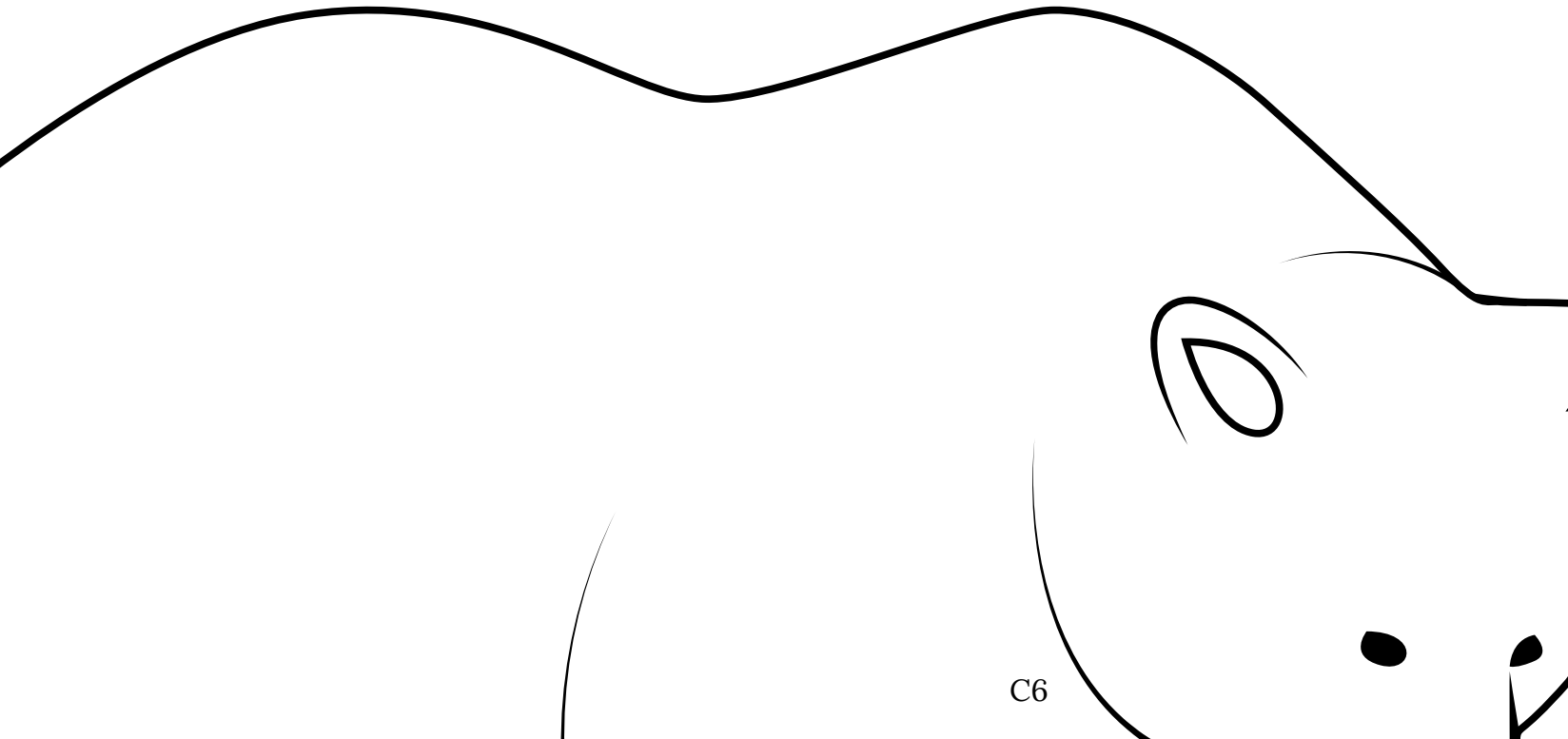
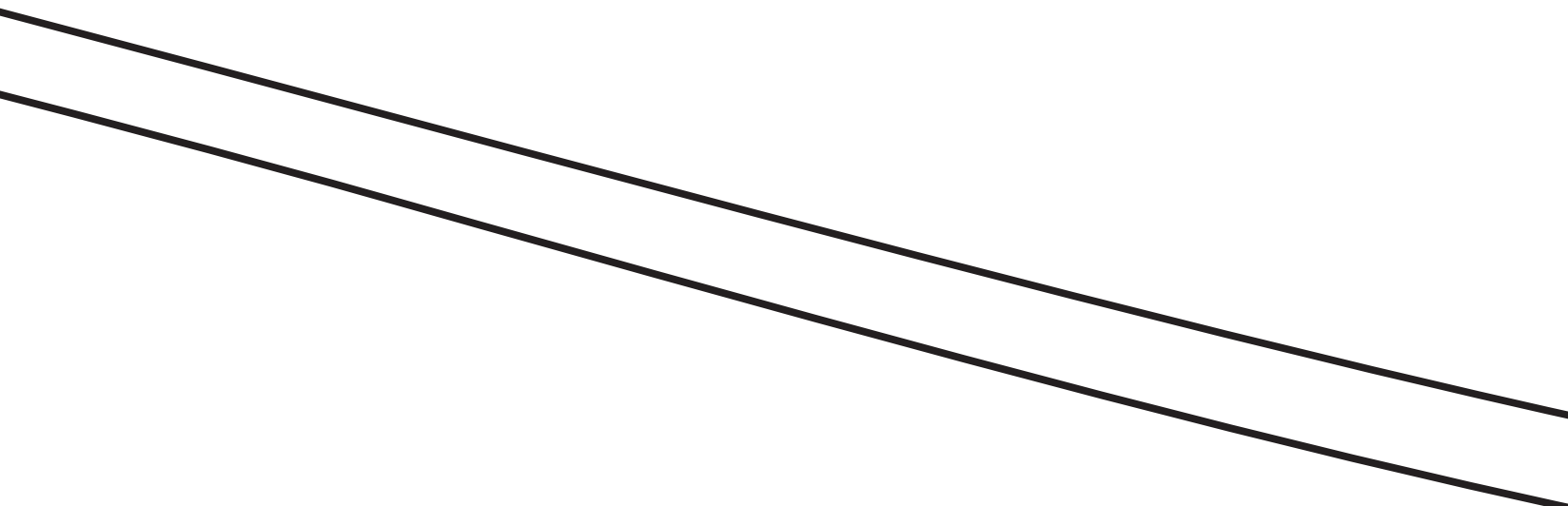
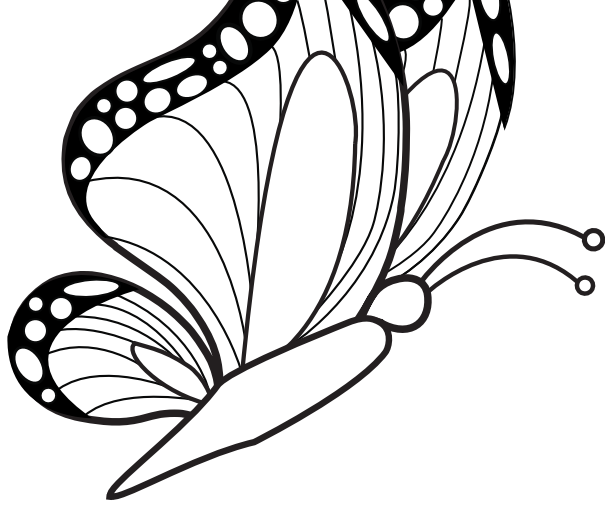

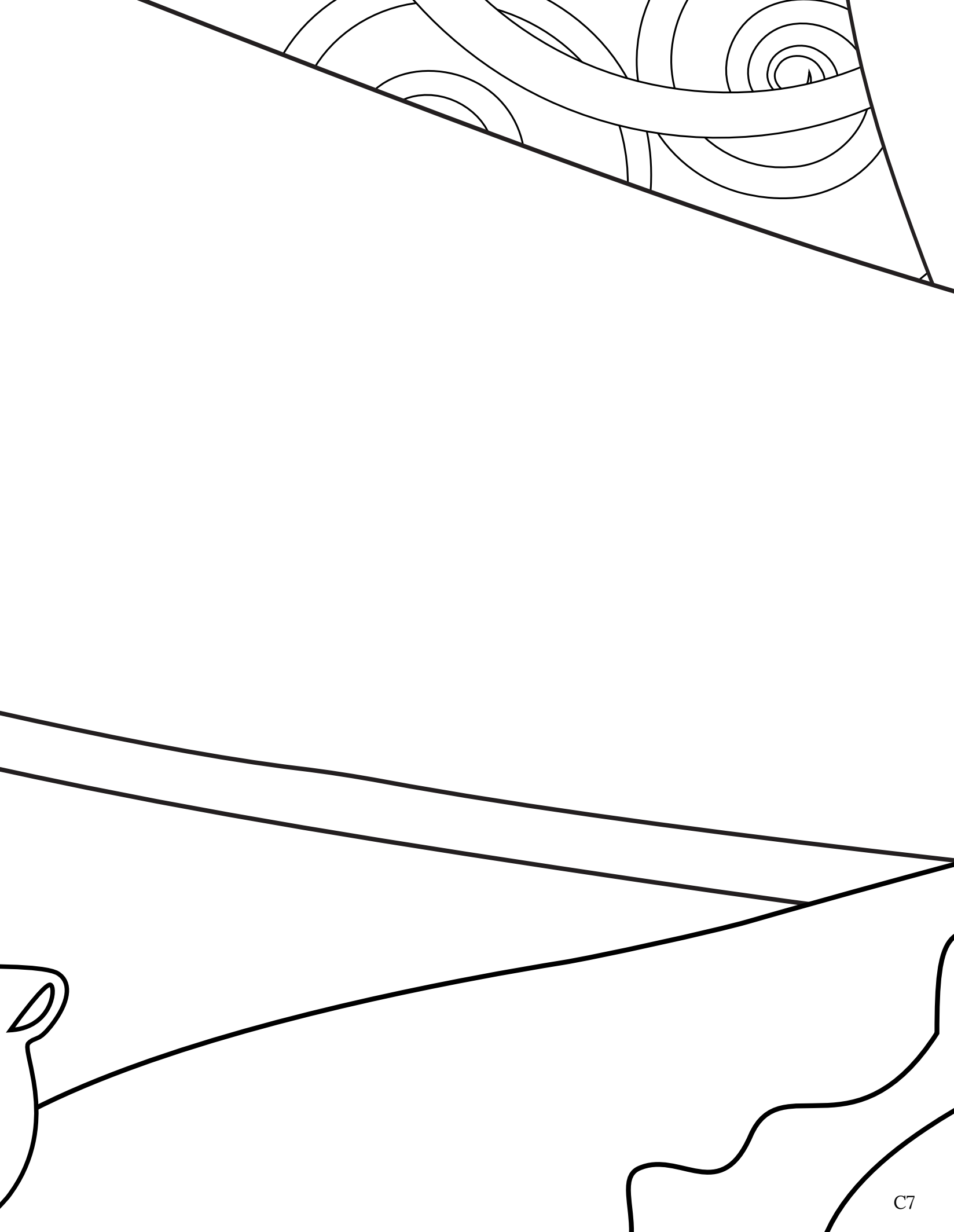

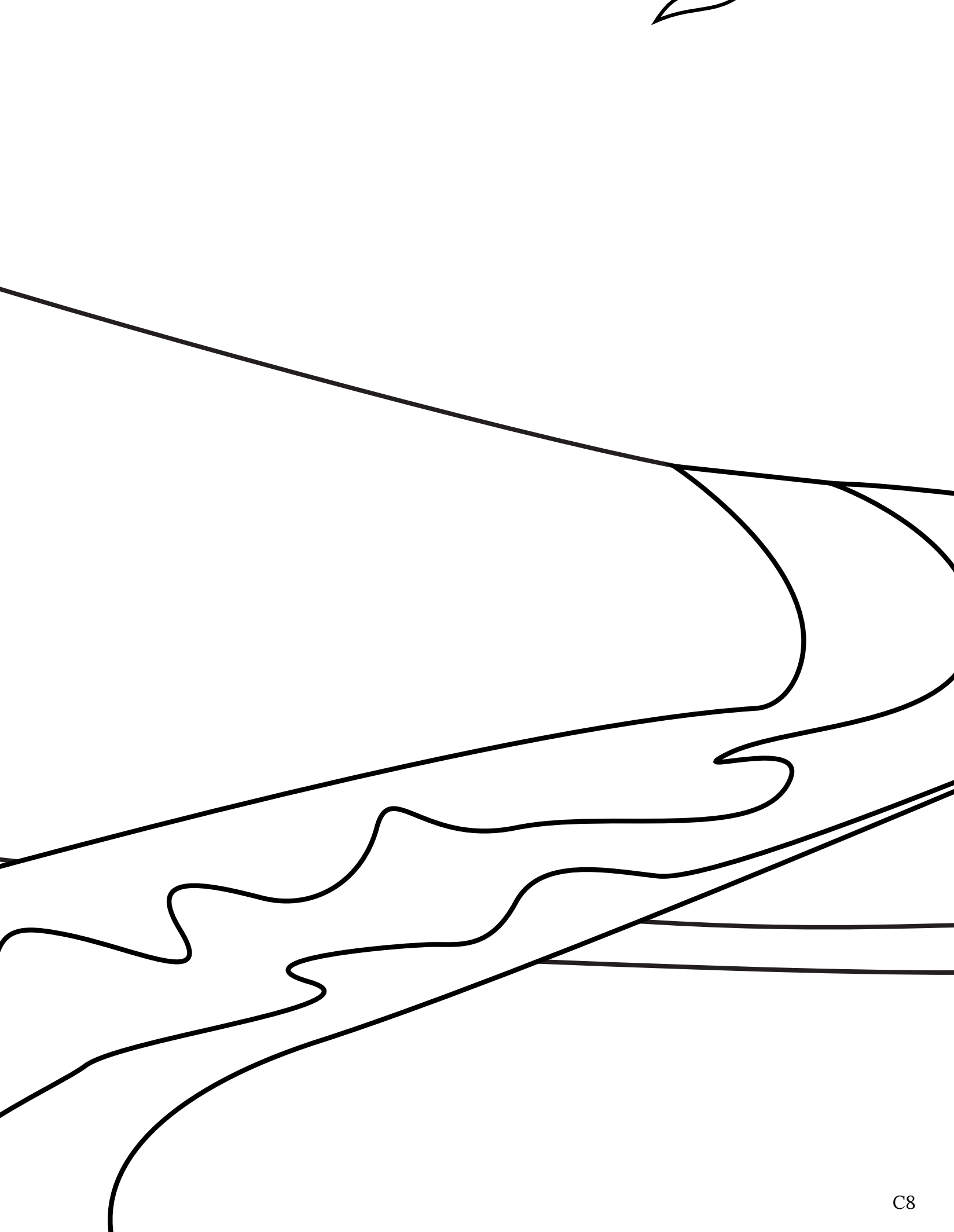

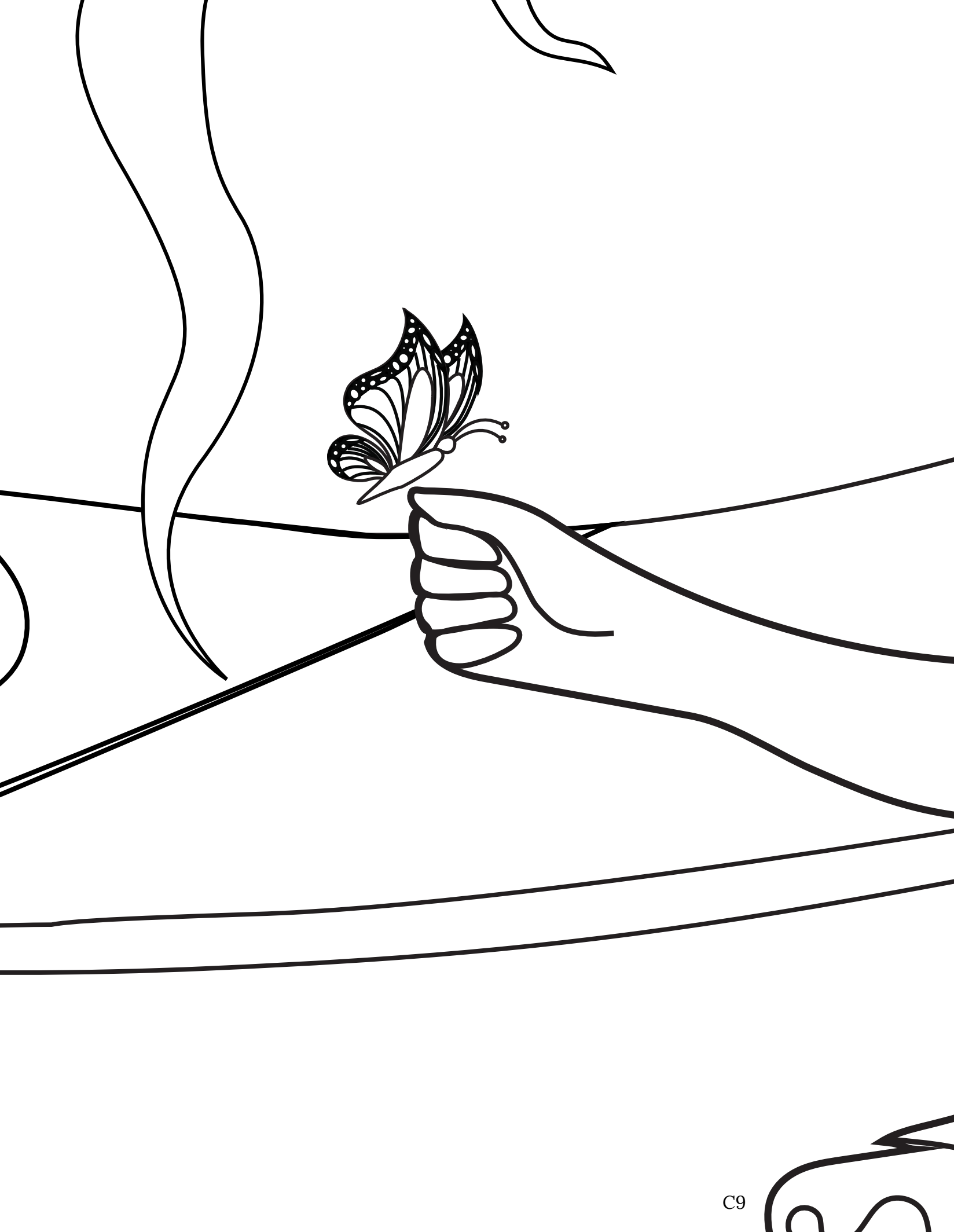







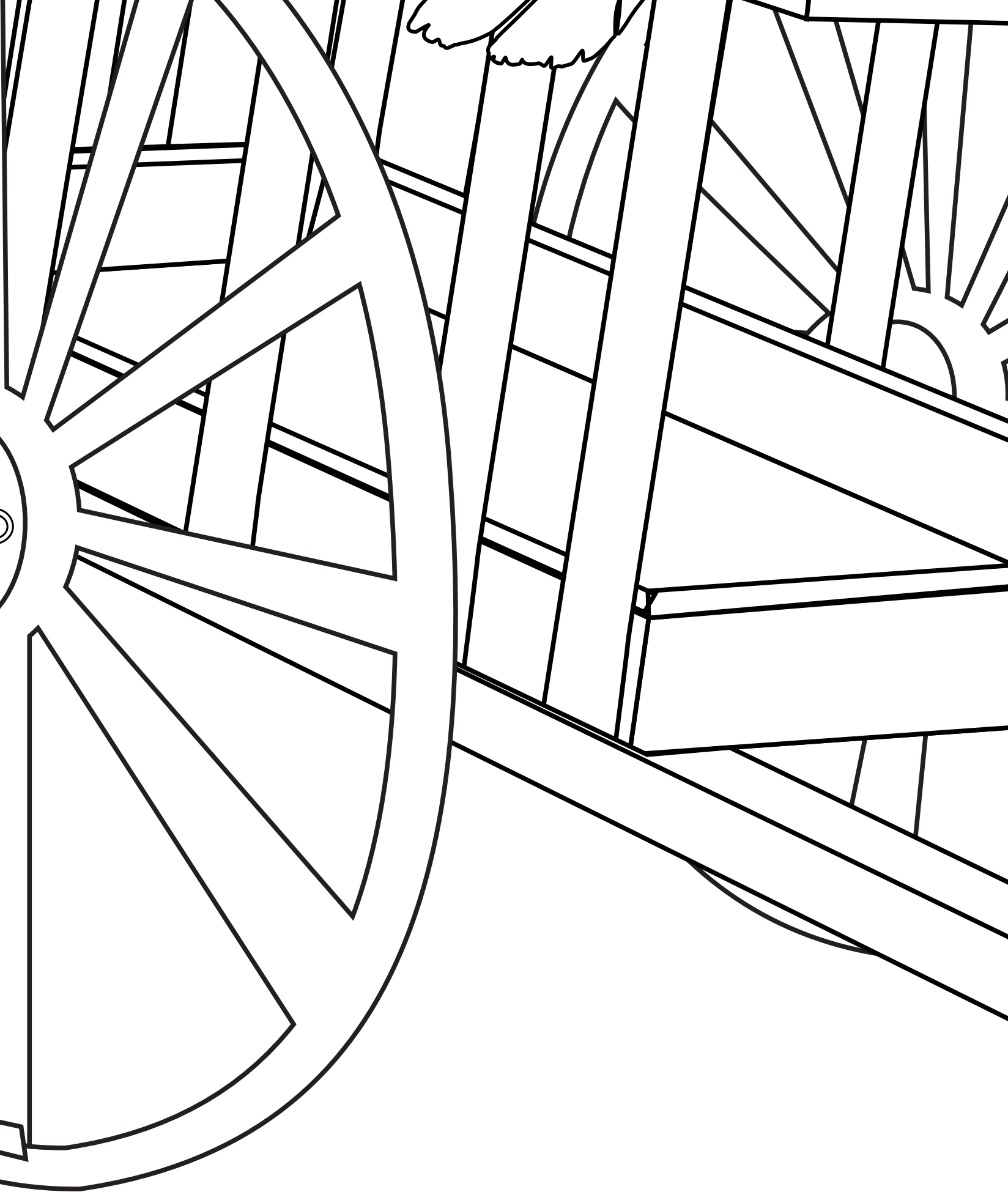

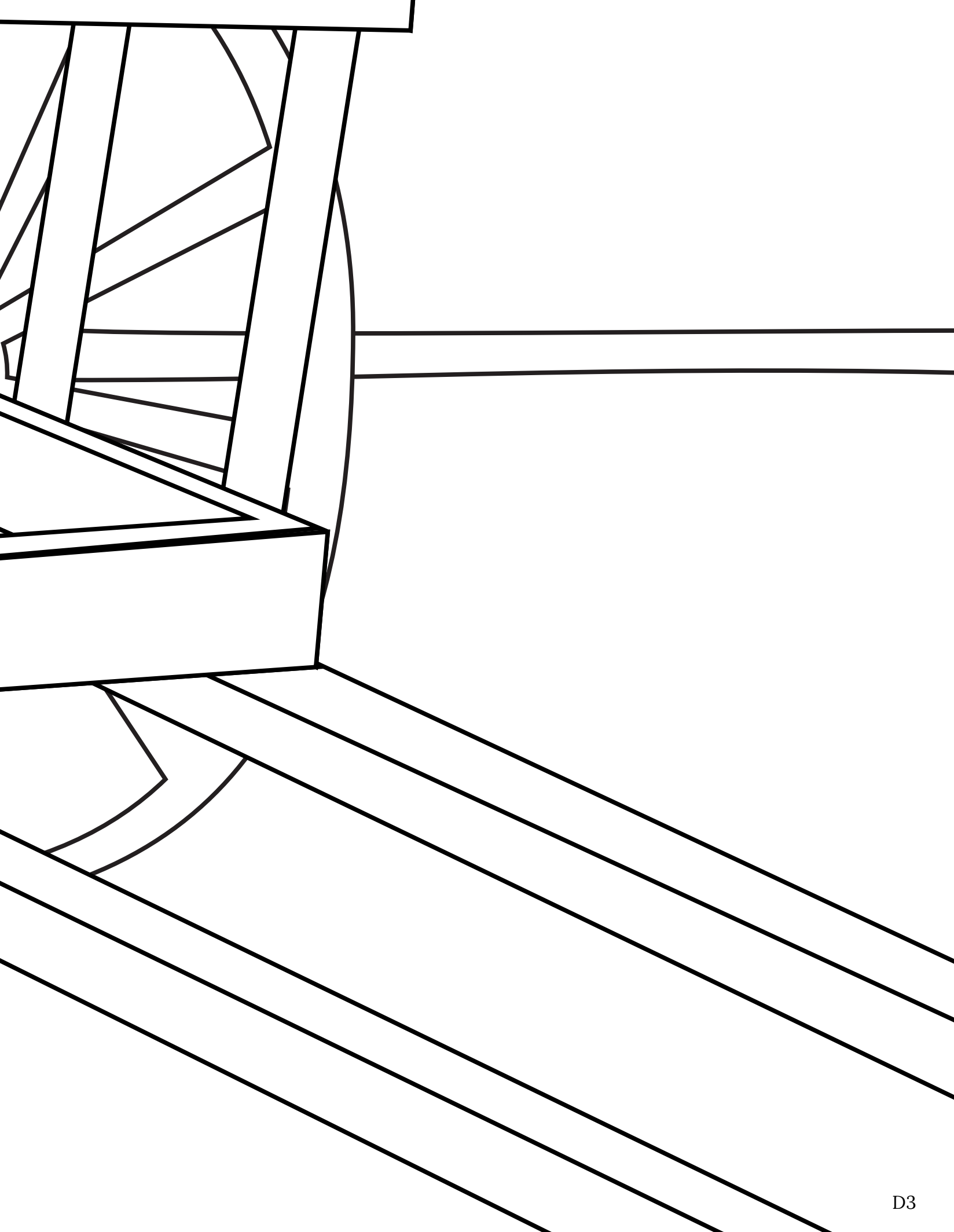

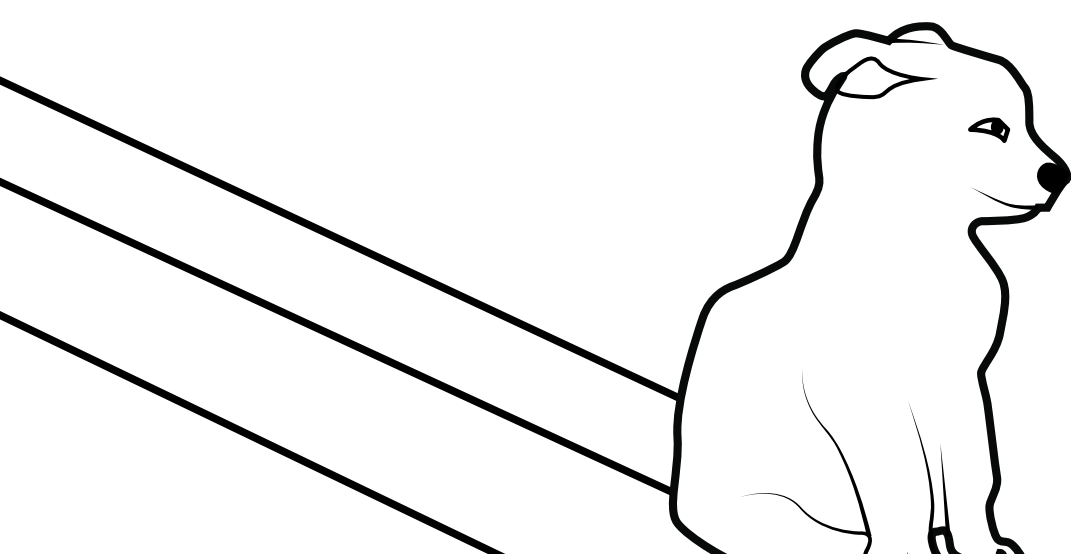
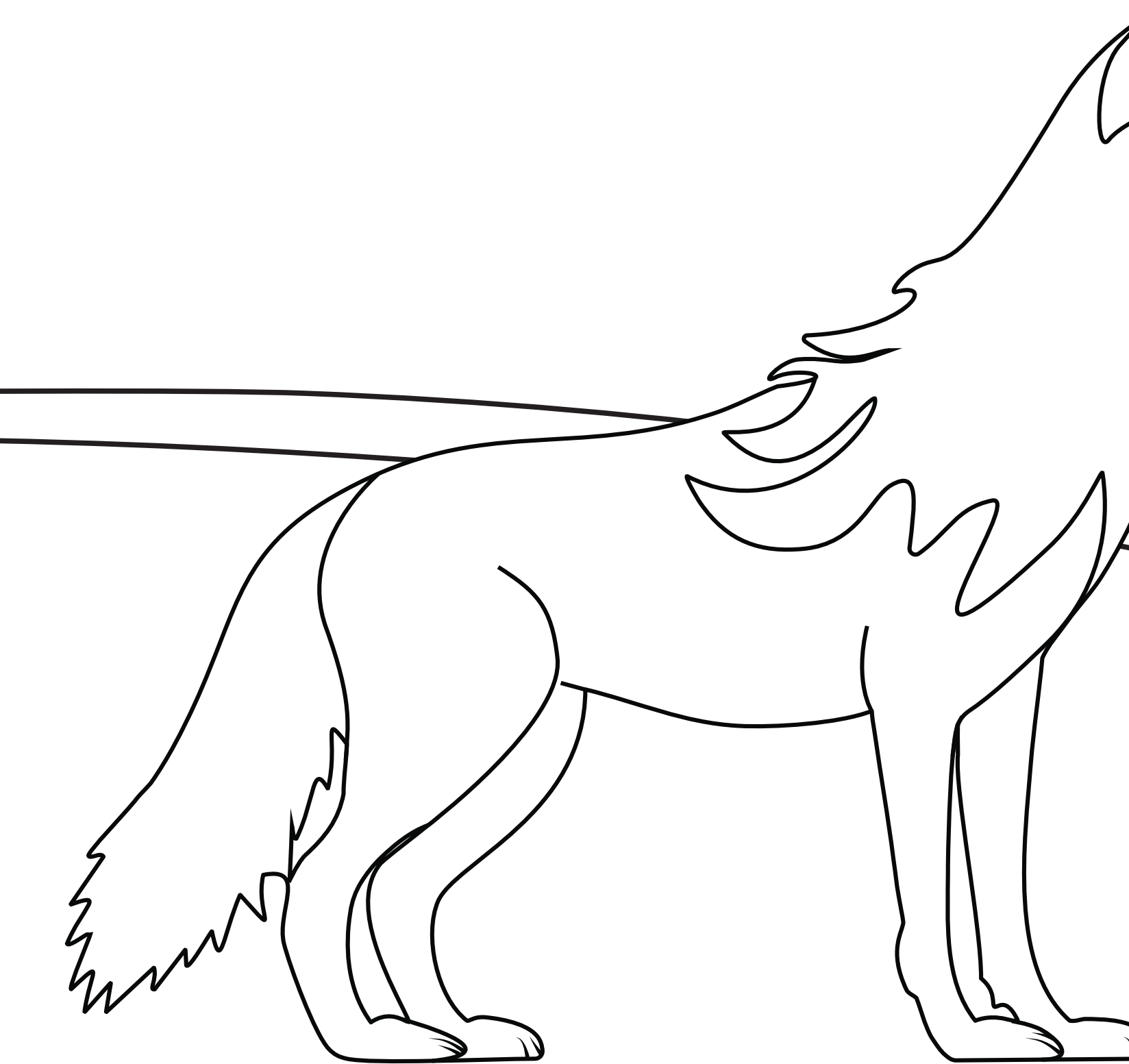

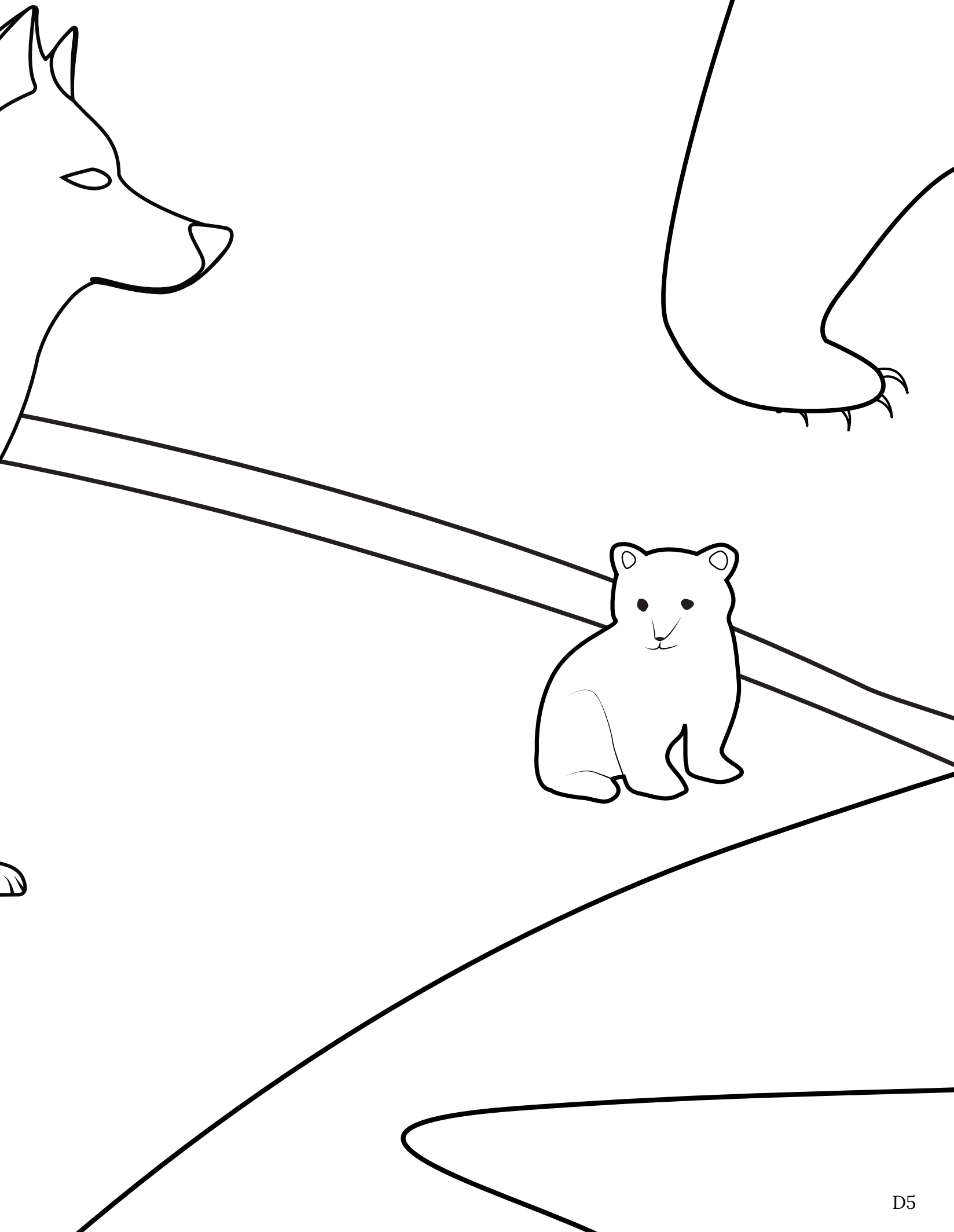

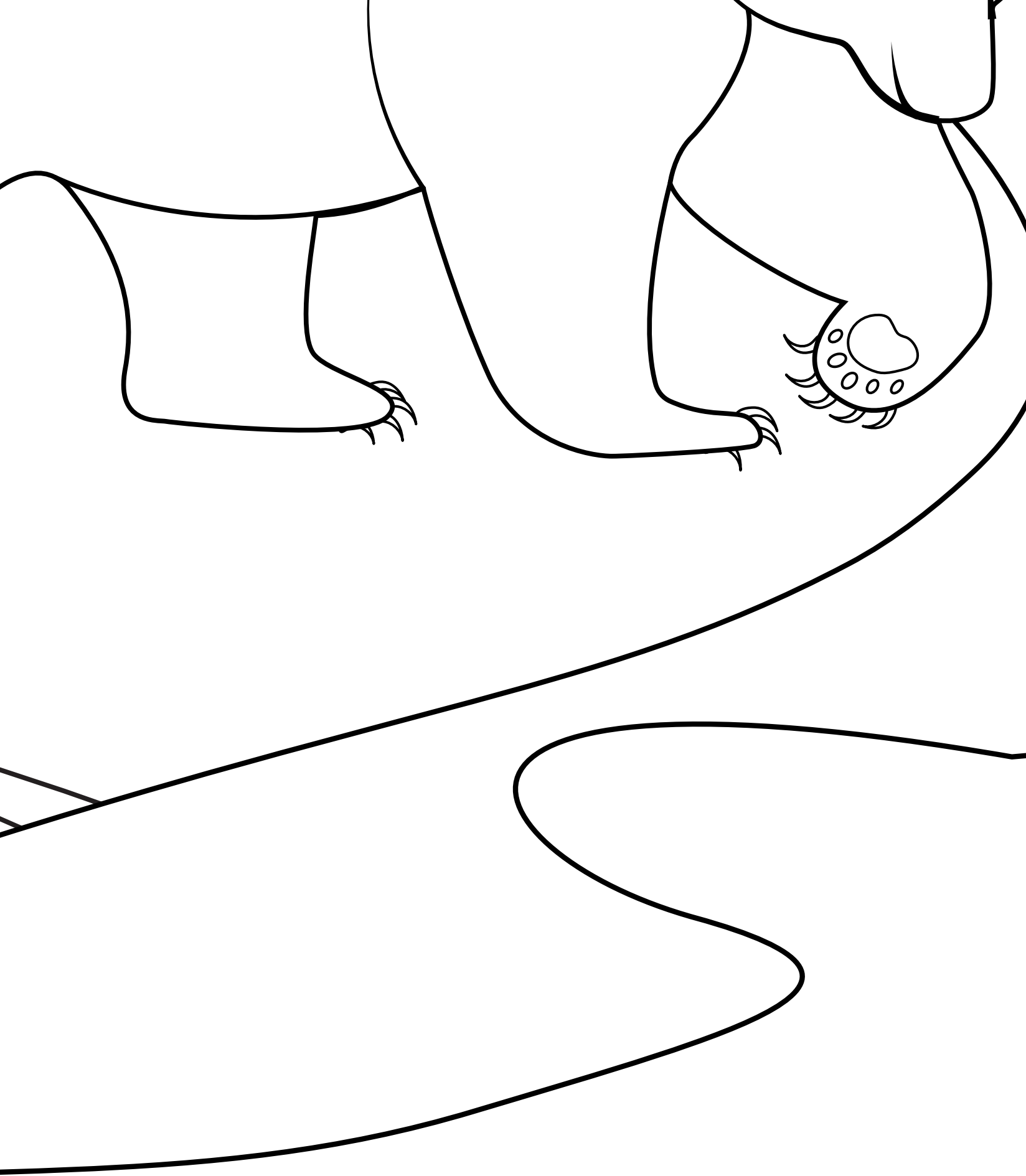



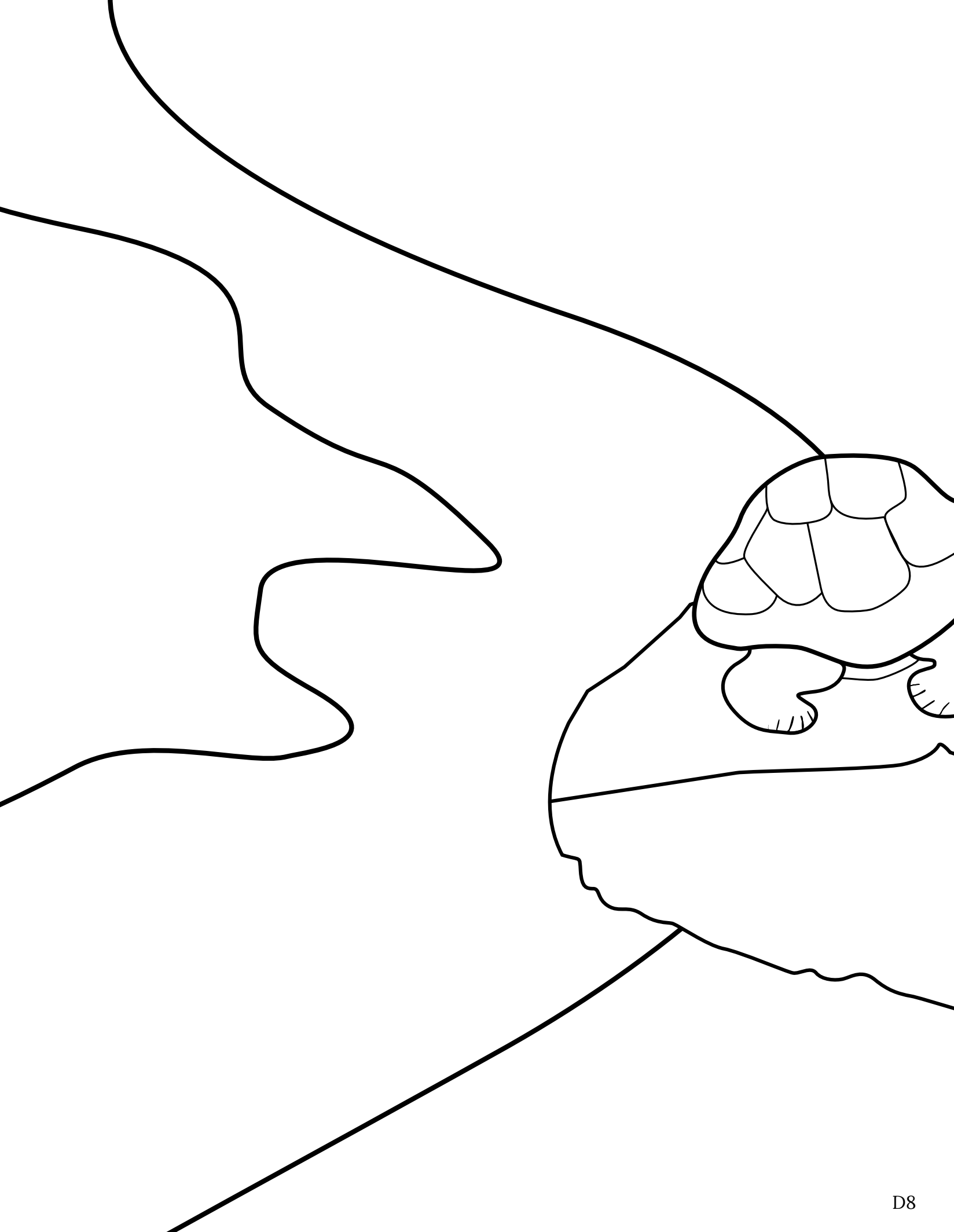

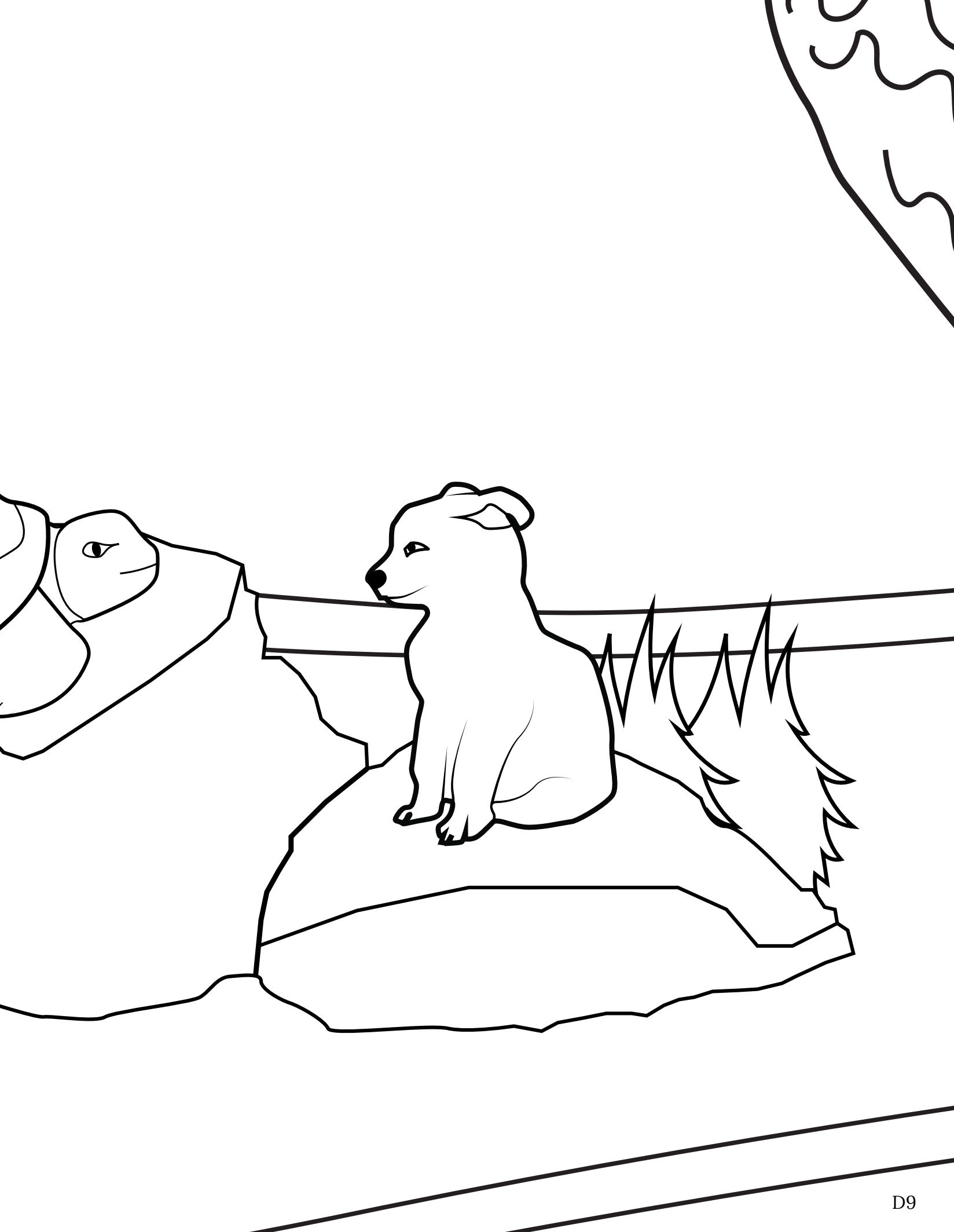

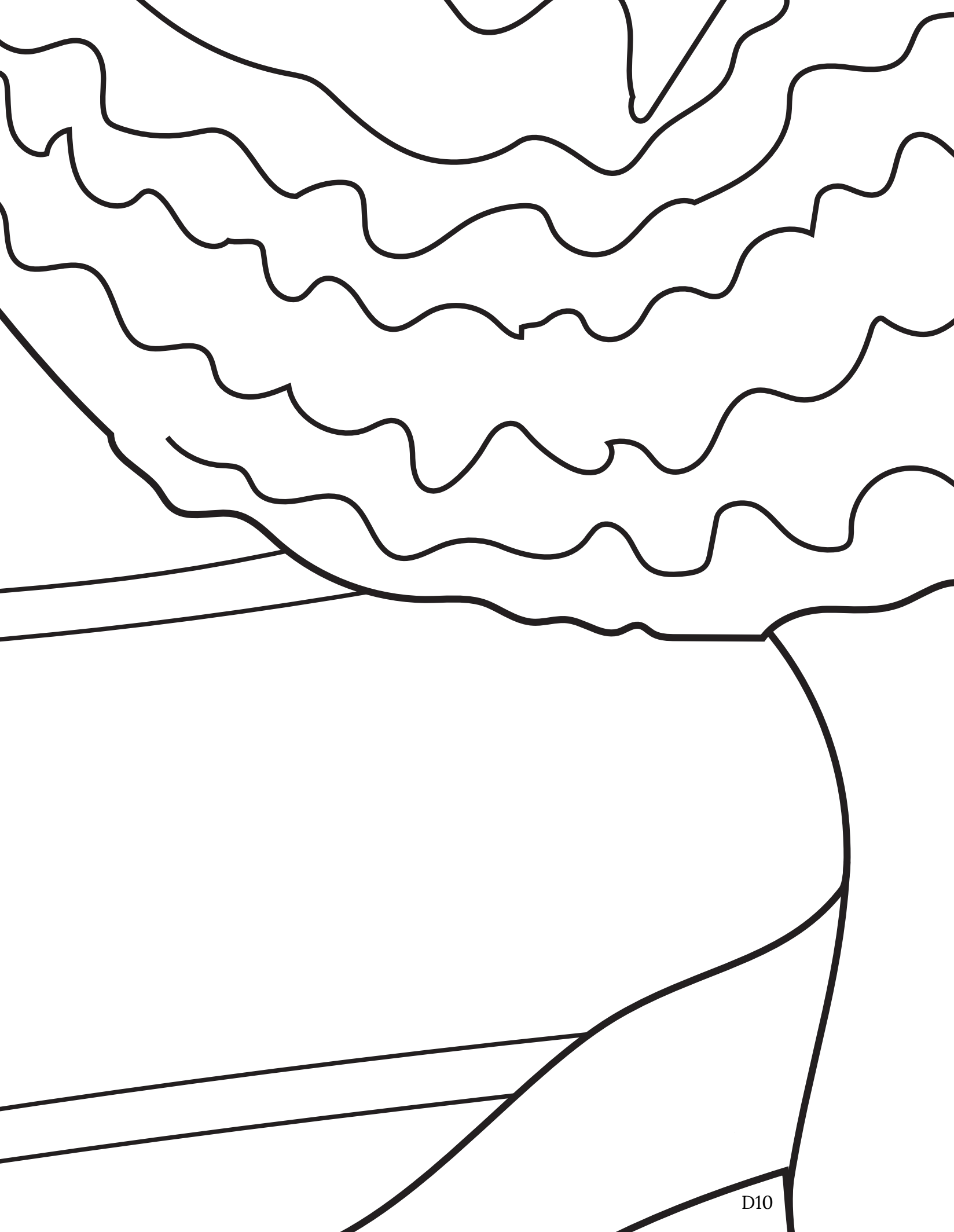

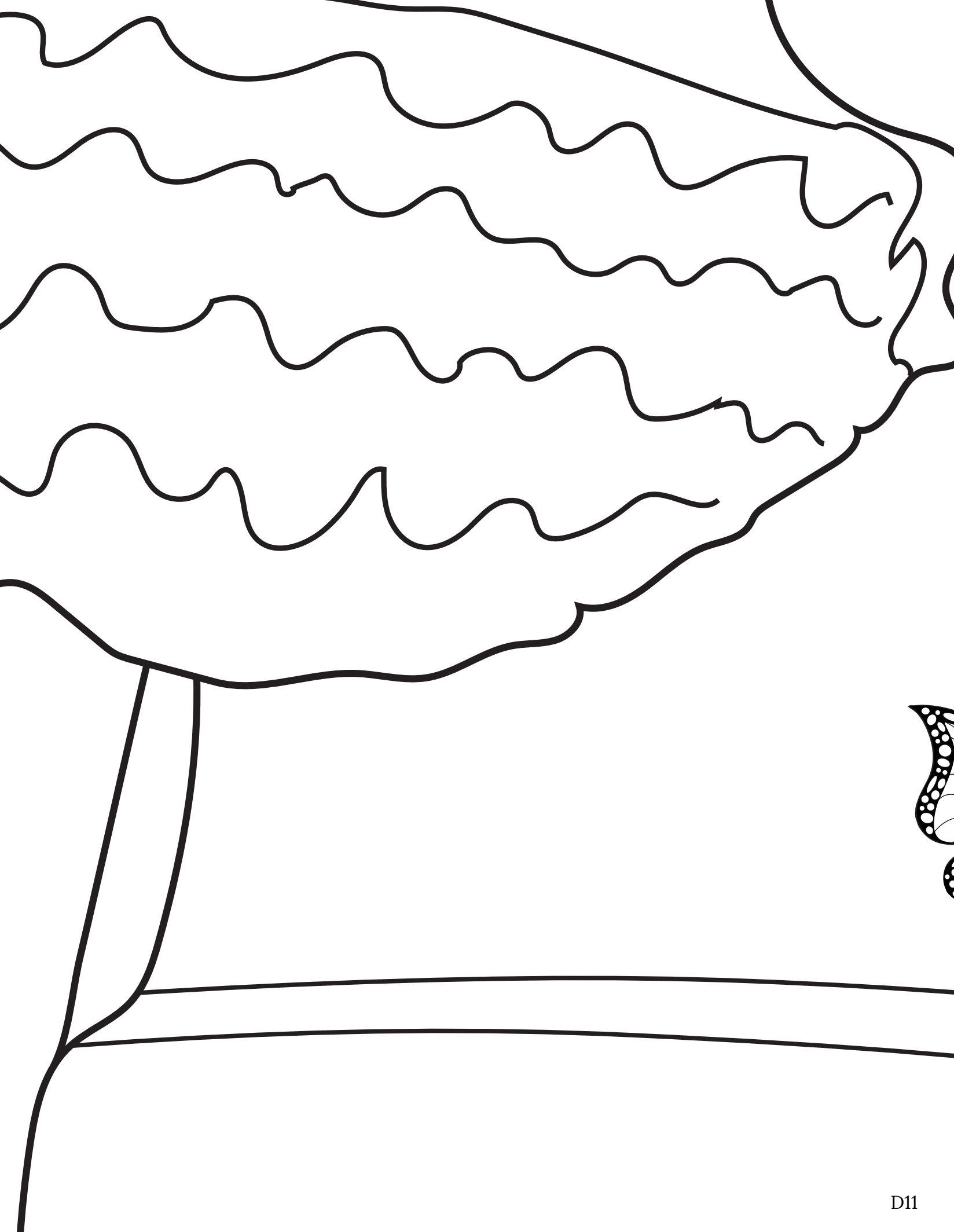



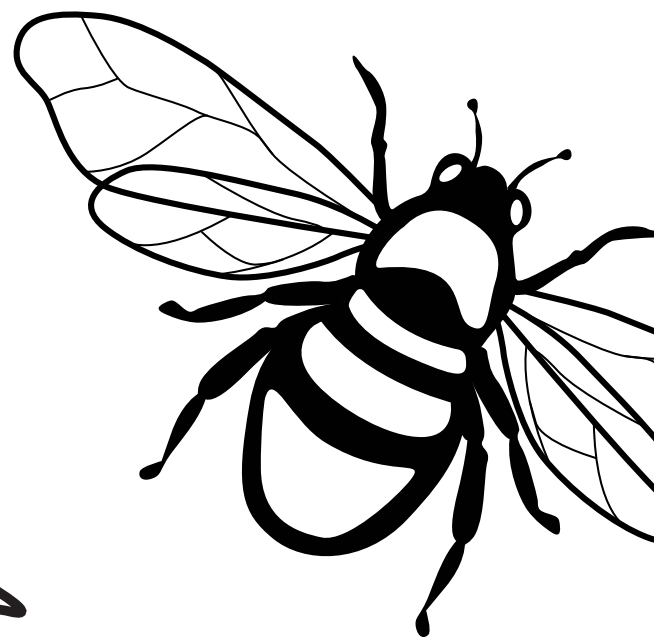
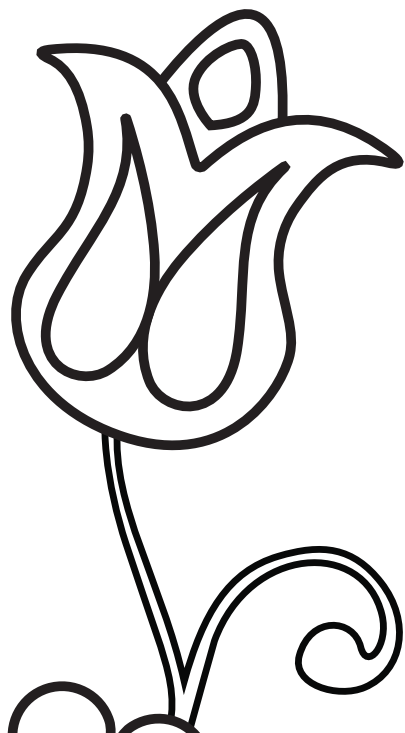

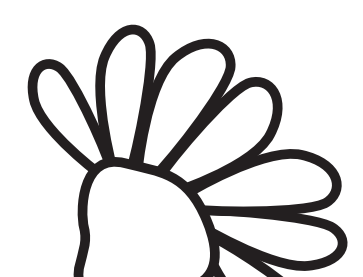
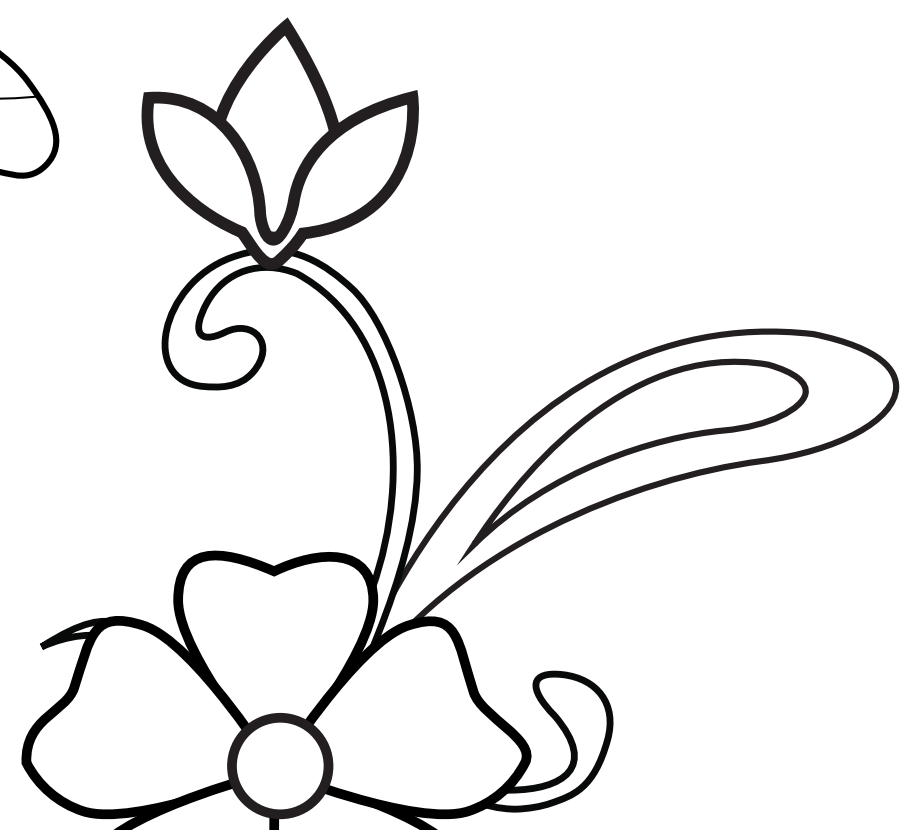
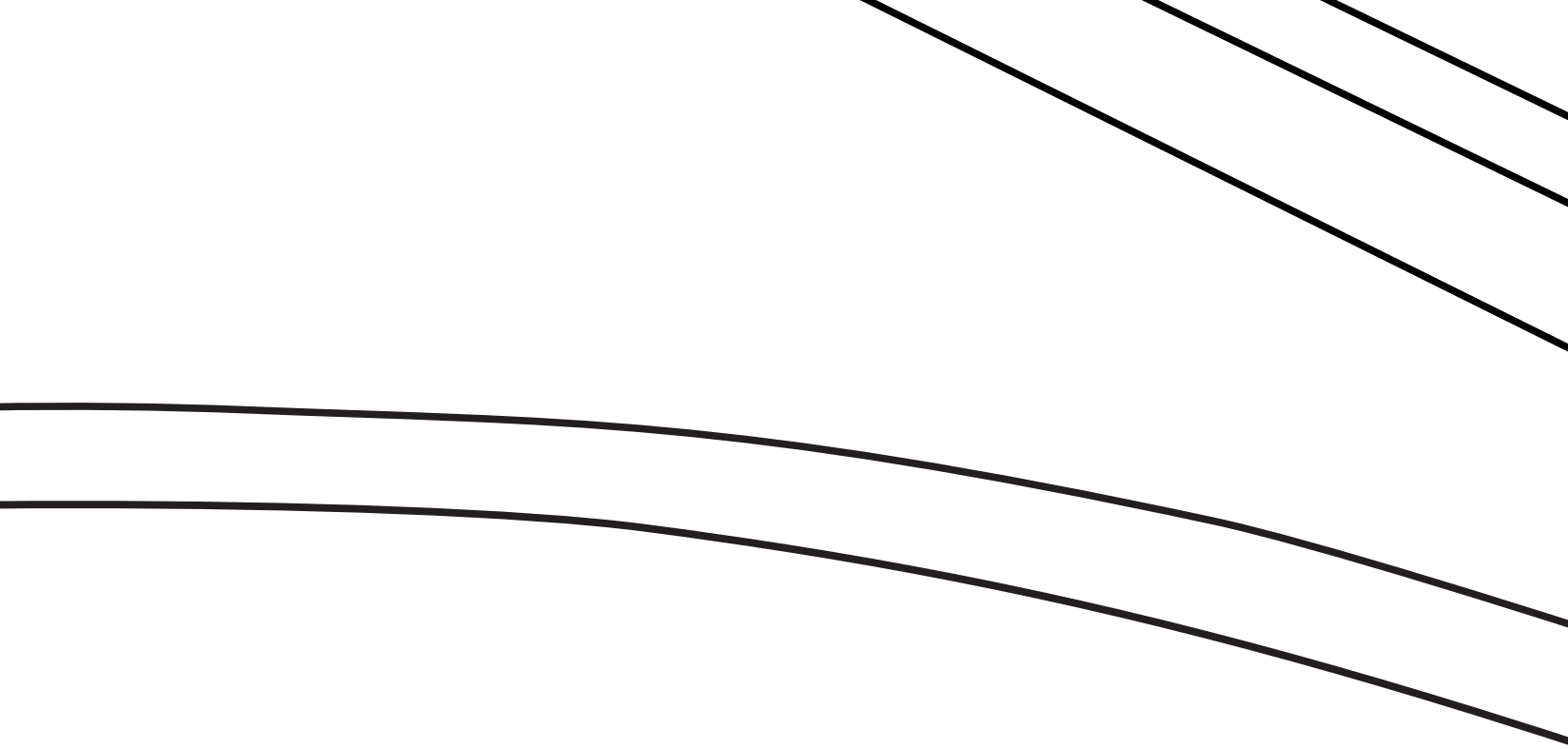

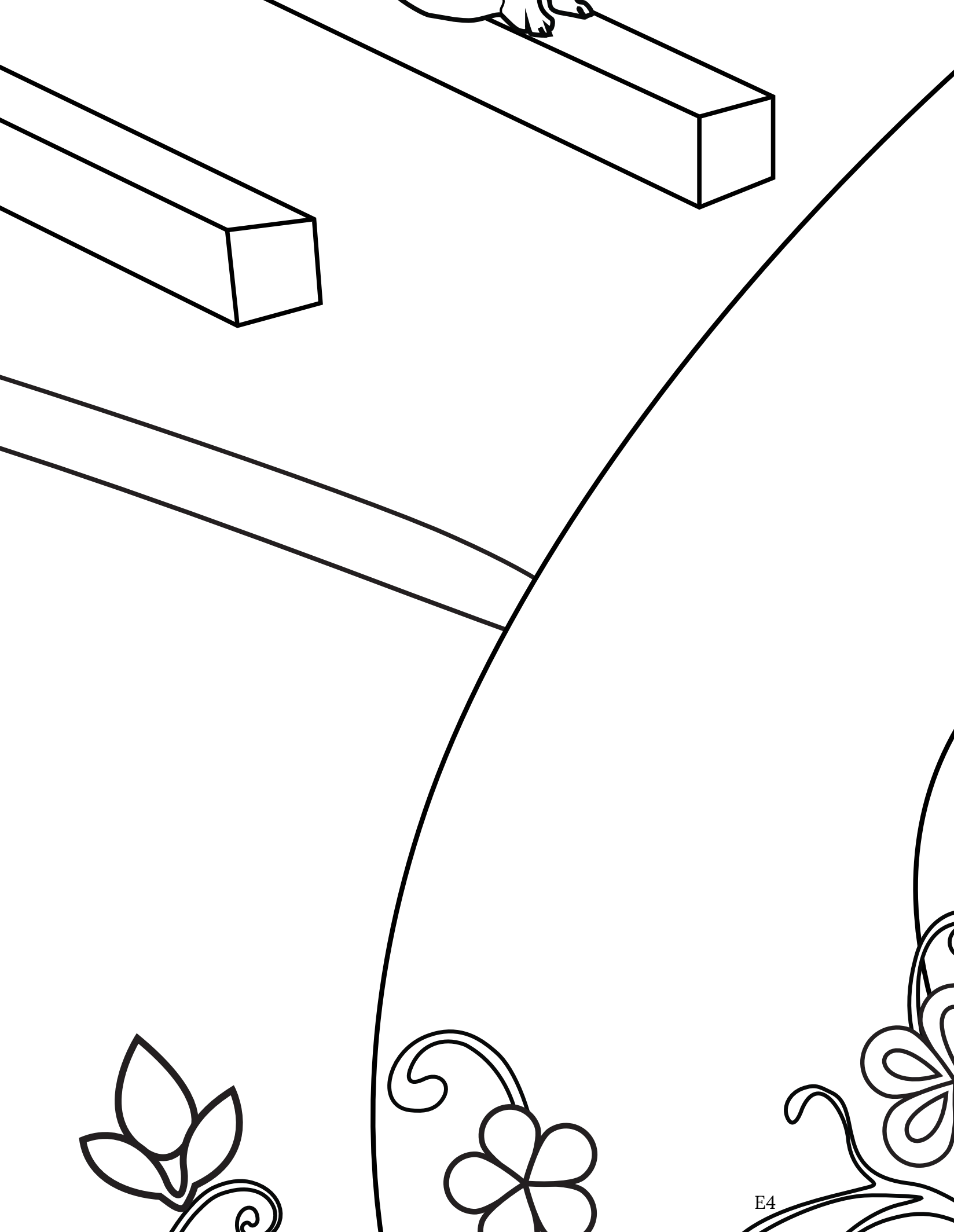

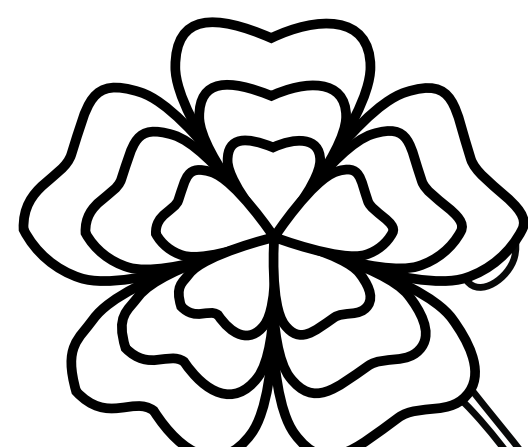
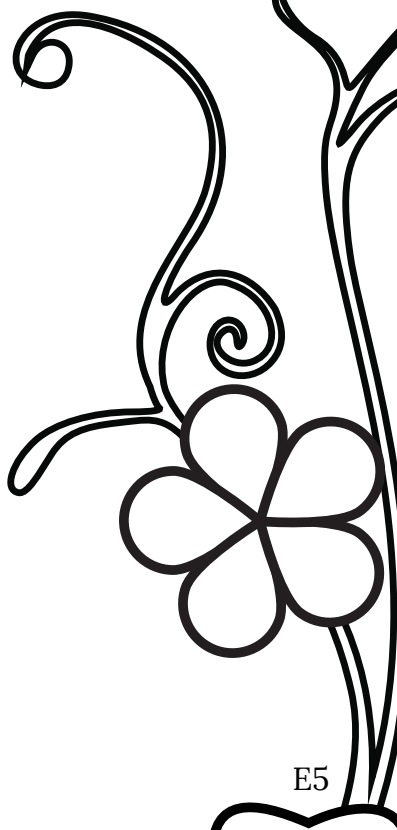
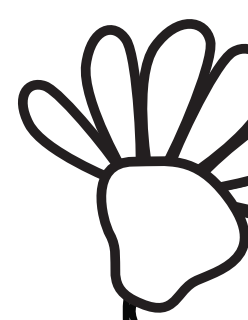





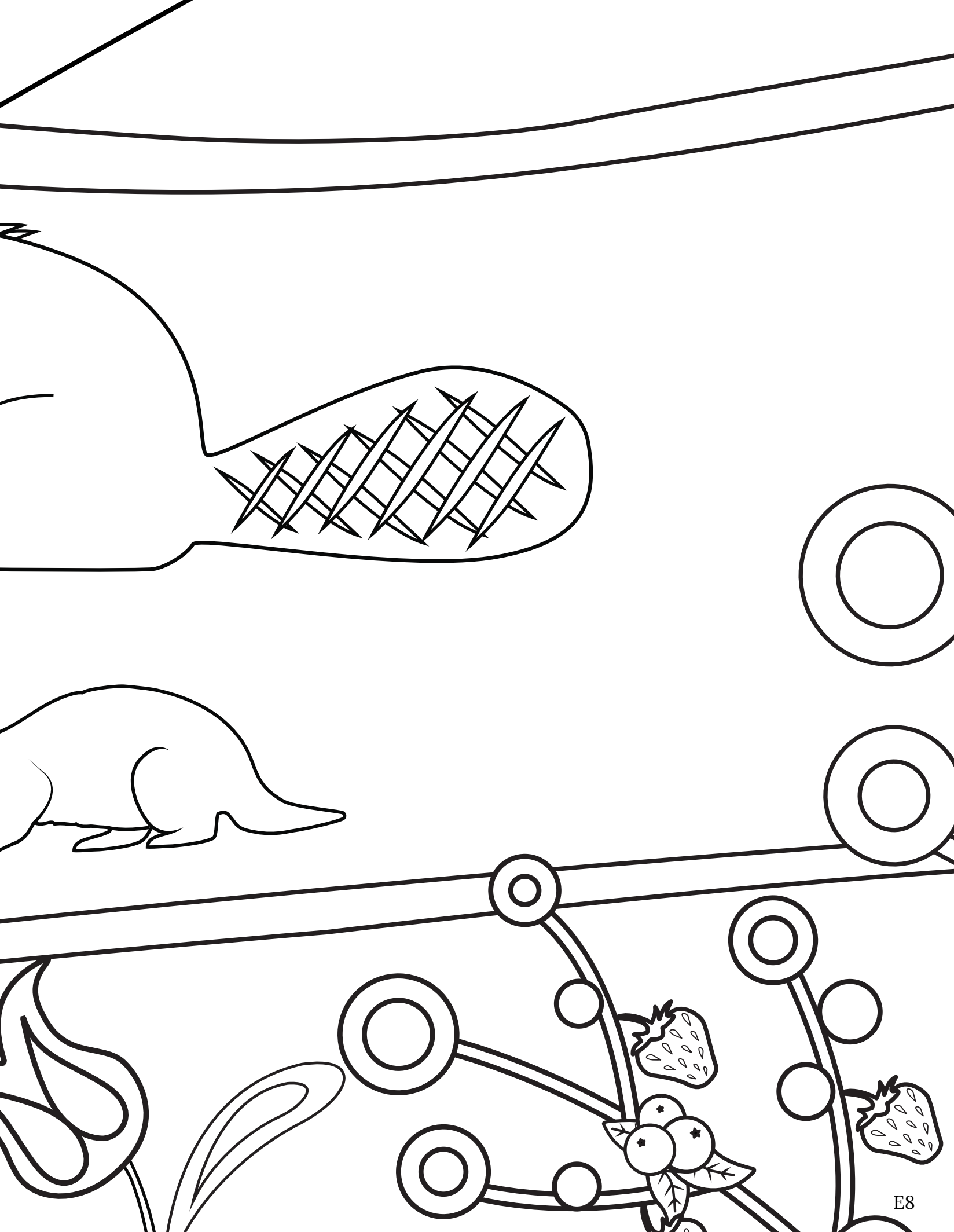

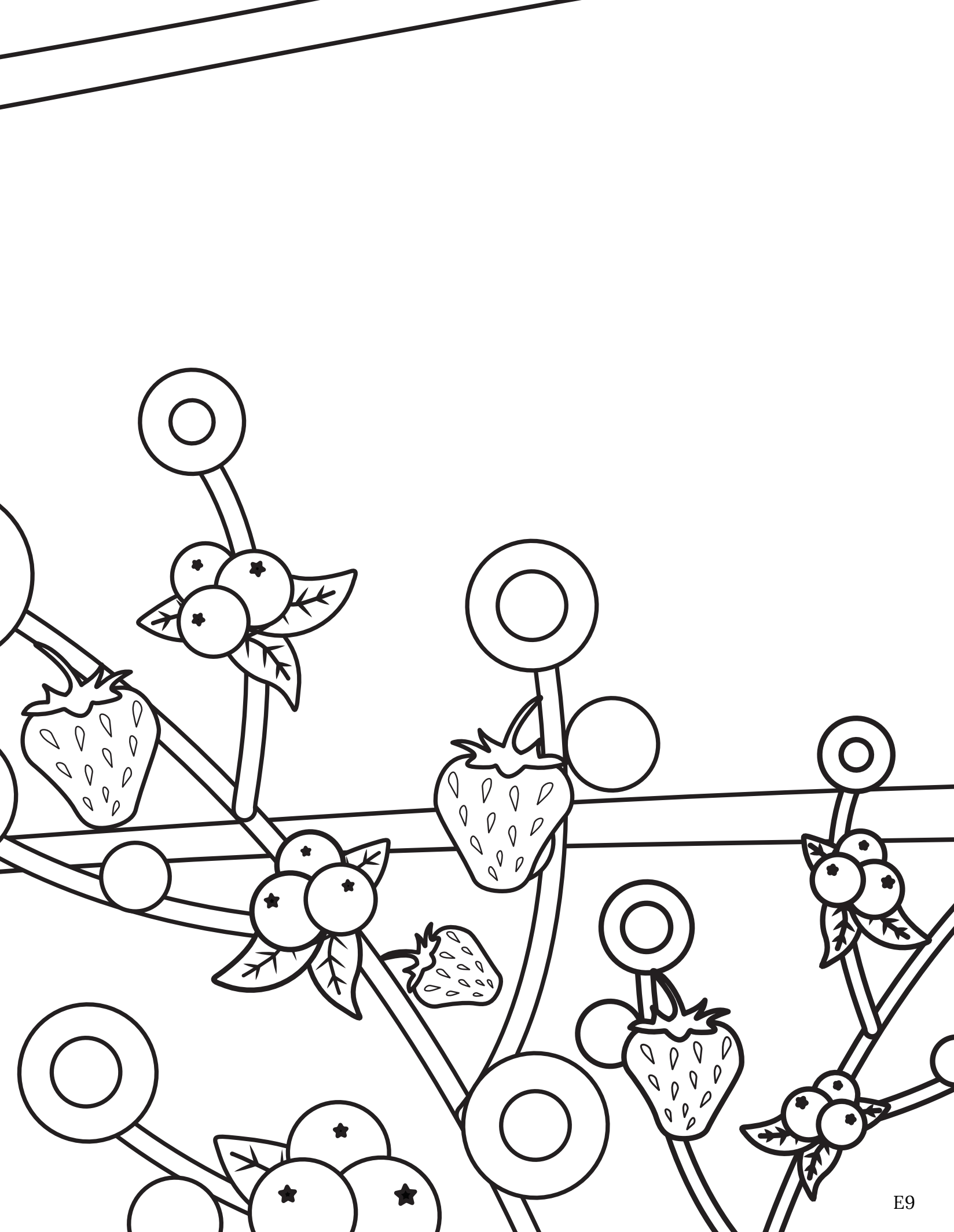

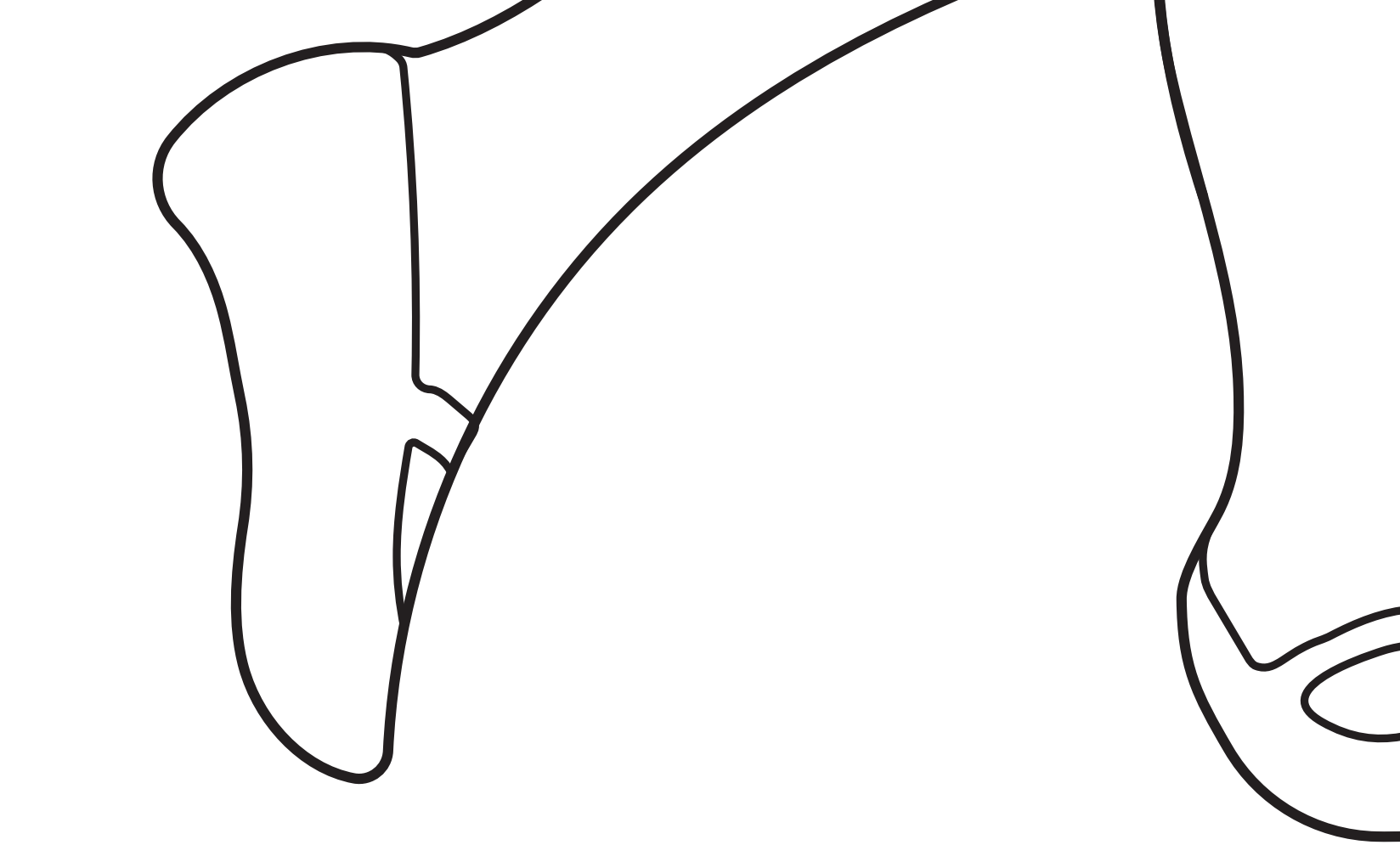









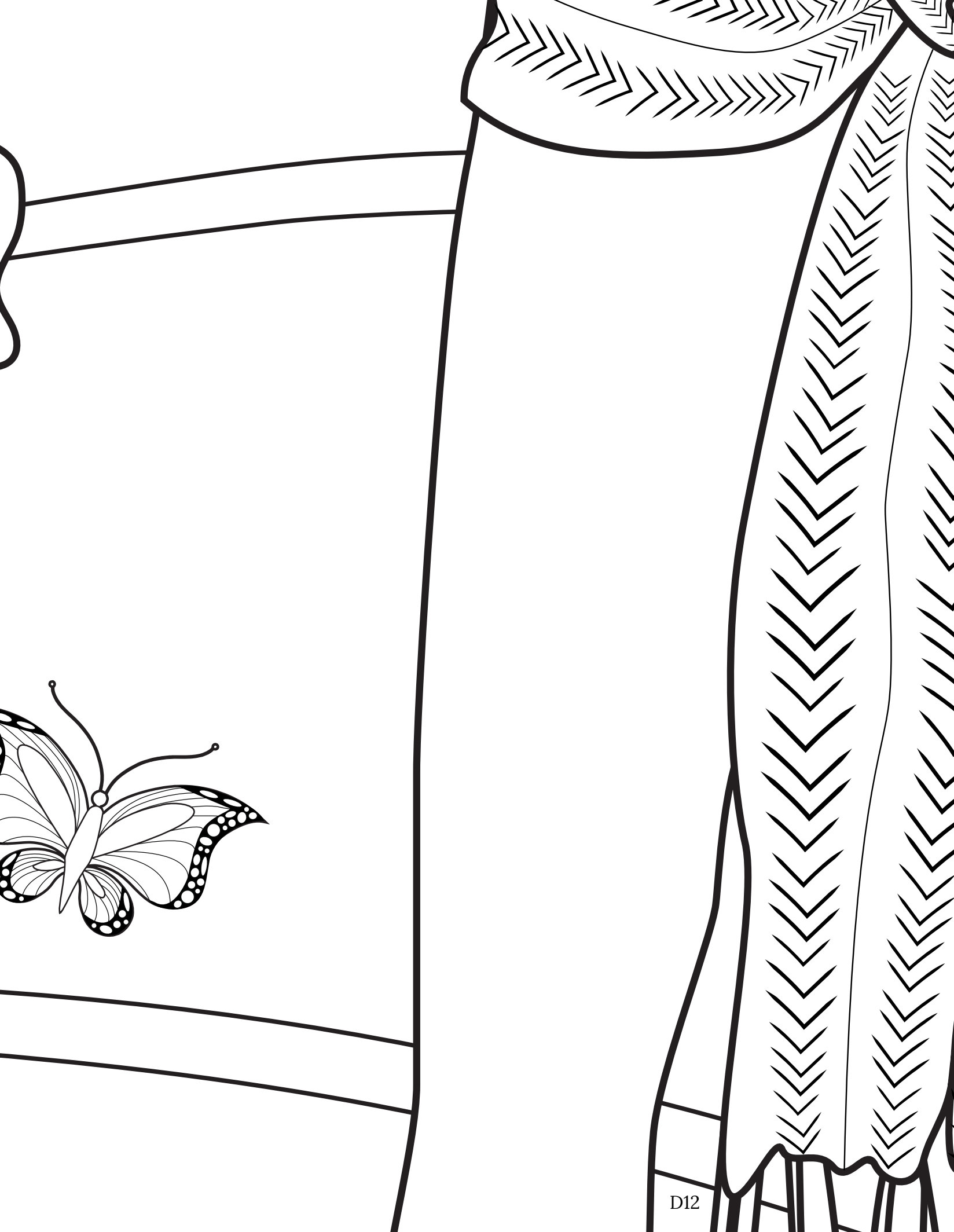















# Paynakishkou Jolene Arcand



Jolene Arcand is a proud Métis artist residing in Treaty 7, also home to the Métis Nation of Alberta District 5 and 6 in Calgary, Alberta. As an ambitious and thoughtful creative and through her passion for art and design, she has produced various collections through personal and commissioned pieces. Jolene is an interdisciplinary artist whose work spans fine art, graphic design, and visual creations in both modern and traditional forms. Her passion for art was ignited at a young age, inspired by her mother and enriched through her lived experiences. Jolene creates, to heal, raise awareness of past and present Indigenous issues, and provoke deep reflection. Her art serves as a powerful medium to express her unique style, feel emotions, and create focal points within spaces while allowing people to understand who she is without saying a word.

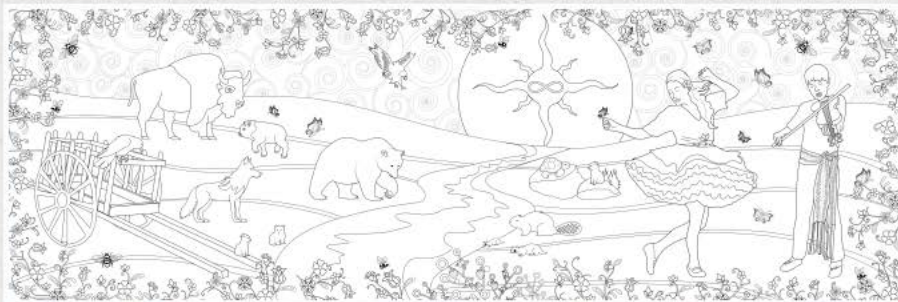

## Métis Connections

This interactive storytelling piece visualizes a Métis perspective and is a tribute to the spirit and connections of the Otipemisiwak (The People Who Own Themselves).

Warmly hugged by traditional berry and flower motifs with bees symbolizing community and service, it includes the red river cart, dancer jigging, fiddle player, sash, and Métis flag, all illuminated by the sun.

The mink signifies the fur trade's importance, while butterflies symbolize youth growth and transformation. Life, love, and meaning derive from the teachings of the 7 grandfathers: Wisdom, Courage, Honesty, Respect, Truth, Humility, and Love.

Beaver: Represents wisdom, showing that everyone has gifts and purpose.

Bear: Symbolizes bravery, confronting threats, and balancing courage with play and rest.

Raven (Sabe): Teaches honesty, urging us to be true to ourselves.

Bison: Represents respect, highlighting Métis perseverance and the importance of respecting all living things.

Turtle: Embodies truth, carrying the beginnings of life on its back.

Wolf: Teaches humility, showing that strength comes from being part of a community.

Eagle: Reflects love, encompassing all teachings and guiding us to love ourselves and our communities